

ASSEM	4027123477	Status	Released	Rev./Iter	2.1
Drawing	4027123477	Status		Rev./Iter	2.1

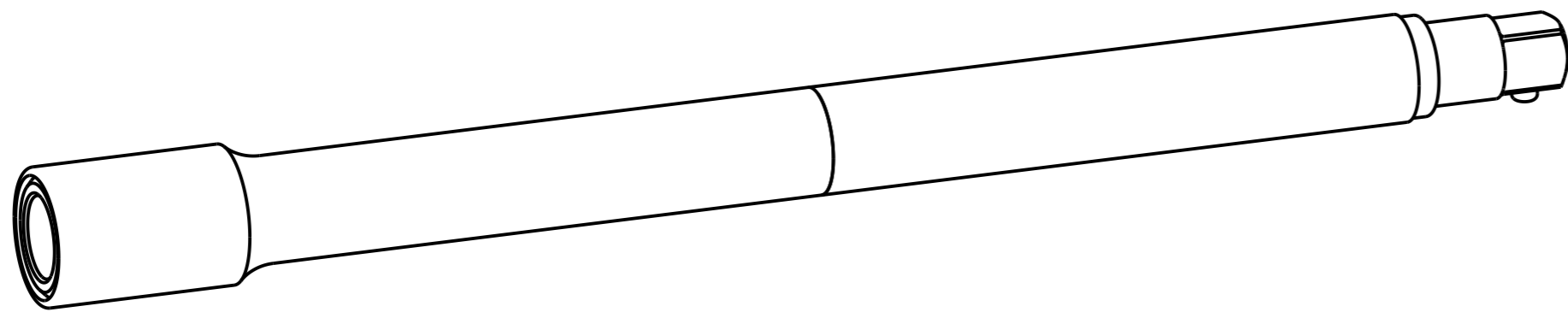
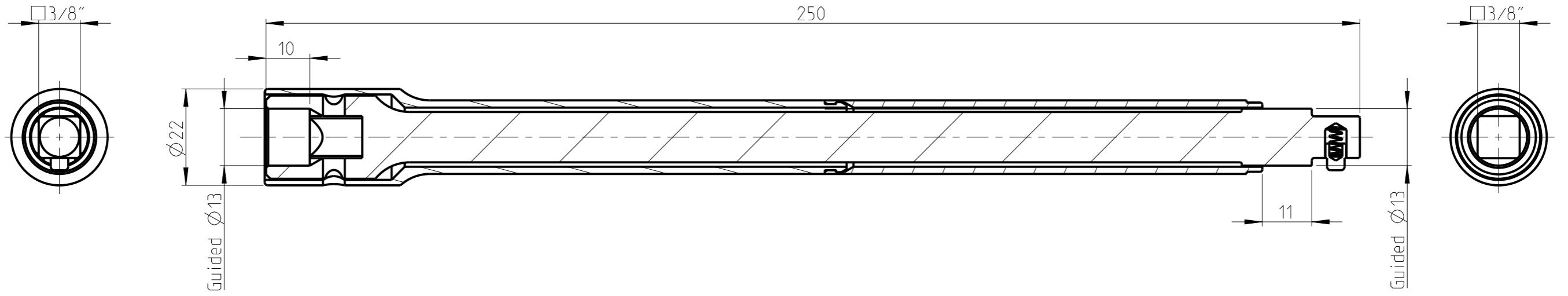

1:1

proprietary document. Not to be used in any way without our consent.

SALTUS

Name	EXT-SQ3/8"-L250-SQ3/8"-R-G-P
Designation	4027 1234 77