

The Atlas Copco logo is positioned in the top right corner of the image. It consists of the brand name "Atlas Copco" in a white, serif font, centered between two horizontal white bars. The background of the entire image is a photograph of a modern industrial facility with a high ceiling, steel beams, and several large, industrial-style pendant lights hanging from the ceiling. In the foreground, a large, dark grey Atlas Copco ZD Hybrid compressor unit is visible, featuring a control panel with a small screen and buttons. The overall lighting is dramatic, with strong highlights and deep shadows, creating a sense of a high-tech industrial environment.

Atlas Copco

A large, semi-transparent blue graphic element is overlaid on the bottom left of the image. It contains a technical drawing of a compressor, showing various components and dimensions. The drawing is a cross-sectional view of a cylindrical component, likely a compressor head or motor housing. It includes various lines, circles, and text labels such as "12.701.030.01", "6-PH COPCO", "C-C(1:3)", "Ø72", "Ø78.8", "Ø72", "10.5", "18.5", "30.4", "14.8", and "5.8". The drawing is rendered in white lines on the blue background.

# ZD Hybrid compressor solutions

ZD 800-4000 & ZD 1200-4100 VSD  
Pressure 25 - 45 Bar



## ***ZD innovation maximizing your efficiency and reliability***

The ZD family is the perfect set up when you're looking for improved quality, reliability and efficiency in applications requiring operating pressures between 25 to 45 Bar.

## Safeguard your reputation

Product contamination can ruin your reputation. You therefore can't afford to compromise on clean, dry, oil-free air for your critical processes. At Atlas Copco, we are a pioneer in air compression and air treatment technologies. We were the world's first manufacturer to receive certification for air purity: ISO 8573-1 CLASS 0. CLASS 0 compressors feed your processes with pure air that safeguards your production processes and protects your hard-won reputation.

## Designed to boost your productivity

Completely designed and developed in-house, our ZD family combines a screw compressor and a booster operating with extremely high efficiency for high pressure applications. Thanks to our dryer technology located at the screw outlet, the booster is condensate-free, thus preserving the internal components for increased reliability.

## Reduce your energy consumption

1. Our unique ZD hybrid solution uses 4 stage configuration, which is on average 10% more efficient than a 3 stage conventional piston compressor.
2. Our entire package includes the option of an MD dryer which consumes almost no energy to further increase efficiency compared to solutions offering either refrigerant or twin tower desiccant solutions.
3. The optional VSD technology can lead to further energy savings of approximately (35%).
4. You can also choose to implement energy recovery systems, which can recover on average 95% of the energy used to compress your air in most industrial conditions.

## Global presence in more than 180 countries

Our products are thoroughly tested but even the best car in the world can fail. Through our global reach we now support customers in more than 180 countries. Quite simply, local presence means minimum down-time and maximum time producing PET bottles, with an even bigger impact on your profitability.



# *Innovative solutions for high pressure applications*

All around the world, companies rely on our expertise and innovations to contribute to their business growth. We help our customers cut costs and boost productivity while delivering sustainable solutions.



## **PET - Unique offering with the lowest possible cost of ownership**

### **CAPEX reduction**

#### **Interested in having a new production line?**

When investing in a new plant, a major capital cost goes to the installation of the compressed air supply with all required ancillaries. Open frame piston compressors require special foundations and anti-vibration mounts, their high noise levels also require to be installed in acoustically insulated compressor rooms to protect employees from the high noise levels. Switching from a conventional system, 3 stage compressors to our unique silent ZD will reduce your total cost of ownership and give you increased value as no money is spent on an extra room while improving your productivity and ensuring a much healthier environment.

---

### Risk reduction / elimination

In the PET blowing market, an interruption in the air supply leads to a loss of product, expensive delays and costly restarts. Of course, you don't want to worry about compressed air, it just has to be there, around the clock, in the right flow, pressure and quality.

Based on our company roots in compression technology, and strengthened by acquisitions of leading manufacturers for high-pressure, we have built upon our expertise and expanded our product portfolio. The ZD family is specifically designed to meet your specific industry's needs and challenges. These advancements are continued through R&D investments ensuring that the latest technology is available to our customers.

---

### OPEX reduction

#### Discover the endless advantages of our technologies

Over a 10 year period, electrical energy account for approximately 80% of the life cycle cost of compressed air generation, therefore getting the most energy- efficient compressed air solution can significantly reduce your operating costs. Our ZD solution is flexible and dynamic, it's a comprehensive solution that starts with our premium high pressure hybrid solution through the most cost efficient compressed air supply in your production.

**How to choose the right solution ?** It's up to you, our local team is ready to help you pick the right combination of the technologies you need.

---

### Make decades of experience in food and beverage work for you

We have set a standard concerning our air purity. This is how we became the world's first compressor manufacturer to receive multiple international certifications. We have received certifications for:

**ISO 22000** on our manufacturing process in Airpower, Belgium.

**ISO 8573-1 CLASS 0** on the level of air purity  
Additionally, we comply to the Good Manufacturing Practice paragraph D10 and in part 210 where it states that compressed air must be of appropriate purity, in our eyes this level of air purity can only be delivered by CLASS 0 machines.



---

### Satisfactory to pharmaceutical air standards

After having serviced clients in the pharmaceutical sector all over the world, we have accumulated the experience and knowledge to help you find the ideal solution and bring you peace of mind concerning your compressed air needs.

# Tested and certified quality

## Why quality air?

### First in ISO 8573-1 (2010) CLASS 0

With us, you eliminate the risk of oil contamination from the compressor. Why risk damaged or unsafe products, losses from operational downtime or jeopardizing your company's well-earned reputation? When tested across a range of temperatures and pressures, no traces of oil were found in the output air stream from our products, our compressors.

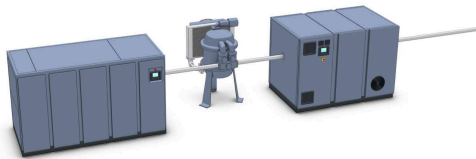

## Why using our Atlas Copco dryers?

### Cost-effective dry air for your application

Our ZD optimized solution with the dryer in between the compressor and booster extend the service life of the booster and increase air quality at lower pressures.

Conventional high pressure drying methods limit the scope of pressure reductions and energy savings. When using a high pressure refrigeration type air dryer, as the system pressure is lowered the pressure dew point rises increasing system contamination and production downtime.

With the Atlas Copco ZD solution, air quality increases reducing maintenance costs while increasing production efficiency.

# *For a smooth production process*

The ZD compressor offers you the best of two industry standards. While the world-renowned ZR screw compressor delivers quality dry air at medium pressure up to 10 bar, the D-booster, thanks to the piston technology, efficiently brings the air up to between 25-45 bar. Designed as a complete, integrated package from one single supplier, the ZD is a true plug-and-play solution.

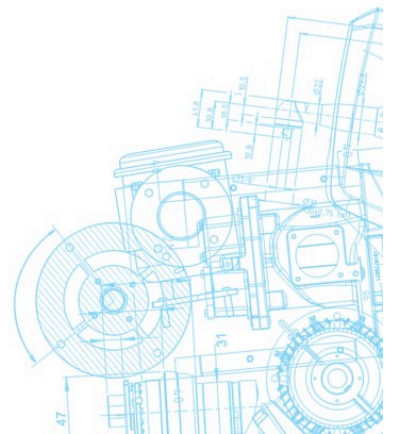
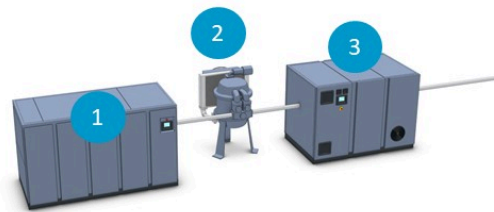



## 1. ZR - The world's best selling Oil-free compressor

- High efficiency intake filter protecting internal components
- Unique element housing design reducing operational temperatures and increasing element reliability
- Specially designed ceramic bearings extending the life of the element
- Integrated oil pump, optimizing oil flow to the bearings
- Unique coating for the element extending operational life
- ZD Flex includes Neos Inverter drive for the tough compressor working environments
- ZD Flex comes with an in-house designed premium quality IP66 Motors

**Providing you reliability since 1956**



## 2. Easy, reliable and compact

A dry compressed air system is essential to maintain the reliability of production processes and the quality of end products. Untreated air can cause corrosion in pipe work, premature failure and product spoilage. Our proven technology ensures maximum reliable process continuity.

- No loose desiccant, compared to solutions offering either refrigerant or twin tower desiccant dryers
- No switching valves preventing failure

**Guaranteed dry air with the Rotary drum technology since 1970**



## 3. D Booster - Build to last

Low piston speed and low interstage temperatures preserve the inner parts of the machines. The horizontal design ensures a low vibration/ pulsation level for increased reliability.

- The highest purity level as per ISO 8573-1
- Solid design and high quality components make it a reliable unit designed for 24/7 industrial service
- Low vibration level: horizontal design (balanced forces), concrete base plate, low center of gravity and integrated pulsation dampers
- Low piston speeds and low inter-stage temperatures

**Pioneering oil-free piston technology in the early 1960s**





## SMARTLINK

**Appreciated by the maintenance team**  
**Monitor your compressed air installation with SMARTLINK**

Knowing the status of your compressed air equipment at all times is the surest way to achieve optimal efficiency and maximum availability.

### **Increase uptime**

All components are replaced on time, ensuring maximum uptime.

### **Save money**

Early warnings avoid breakdowns and production loss.



# The flexibility the ZD family has to offer

Are you interested in a high pressure compressor or a complete compressed air solution?

The ZD family not only provides you high pressure air but also offers you low /medium pressure smart air solutions while driving down investment and operational costs.

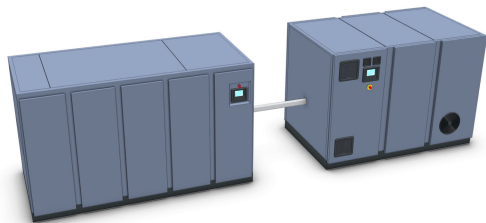

## ZD Premium - Dedicated to high pressure applications

- Maximum efficiency with 4 stage oil-free air compression
- Integrated dryer option extending service intervals of the booster
- Variable Speed Drive available
- Easy installation, no foundations required
- Lowest cost of ownership
- Low noise and vibrations protecting employees
- SmartLink included

## ZD Xtend - No need for a standalone medium compressor

Thanks to our ZD Xtend, you are able to handle medium pressure in your production line. This solution saves substantially over extra standalone compressors.

- Medium pressure air available thanks to a larger model screw compressor
- Medium pressure vessel
- Medium pressure regulation valve



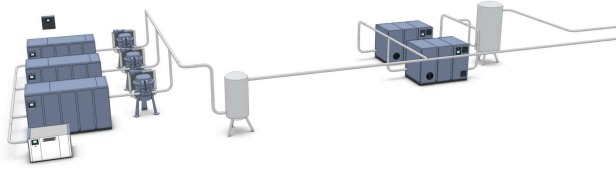

## ZD Flex - Designed to handle multiple pressures

Does your factory only need high pressure air? In case your factory production process needs lower pressure air requirements as well, have you ever considered consolidating them?

By consolidating the existing medium pressure and high pressure air requirements, we are able to create the most appropriate solution for your needs, whether they are investment costs, operational costs or both? The new ZD Flex is the answer to all your needs.

Inspired by many customers we have been working with, this modern version of the ZD Flex gives you the possibility to fully optimize your compressed air process.

## Easy to transport, installation and relocation

A key reason why operators love the ZD is its silence. With an operating noise level up to 76.4 dBA, normal conversations can be held in its immediate vicinity.

- Fitted on a concrete base plate
- No special foundations are required
- No anti-vibration pads are needed
- Slots are integrated for easy transport and handling

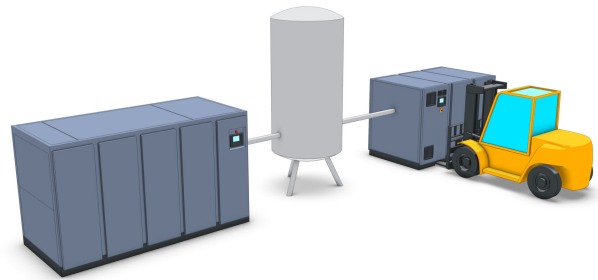

# *A significant potential in energy-savings*

Compressors, not often in the spotlight, yet a vitally important component of PET bottle production, and with significant potential in energy-saving.

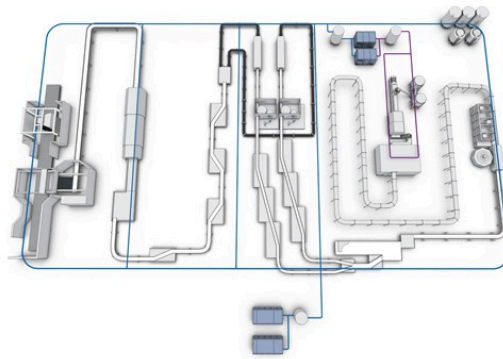



### 1. Instrument air

- The first two stages are based around screw compression technology which is the most commonly used technology for up to 10 bars because it is energy efficient, cost effective and low in maintenance. This leads to 10% extra efficiency during operation
- The **Z(D)** is equipped with a dryer at booster inlet to eliminate condensate
- Precise pressure control allows a tighter pressure band and a lower average working pressure, resulting in reduced energy consumption



### 2. Medium/Low pressure air receiver

Compressed air demand typically fluctuates, during day and night, even minute to minute, second to second. Those fluctuations can cause switching losses in compressors. A properly sized compressed air receiver will deal with these short term fluctuations and will avoid potentially nervous switching of compressors. Thus it will contribute to the efficiency of your compressed air installation.



### 3. Medium pressure network

Piping is an essential part of your compressed air system, in order to make sure your compressed air is properly distributed, we recommend a ring network for an optimal performance and efficiency.



### 4. High pressure compressor/booster

- Compared to traditional piston technology, our high pressure booster saves energy and increases the life-time of moving parts (rings, packings, valves)
- (Z) **D** boosters are also available in Variable Speed Drive versions, allowing for on average 35% energy savings due to:
- Unload losses are reduced to a minimum
  - Load/ no load transition losses are eliminated
  - Precise pressure control allows a tighter pressure band and a lower average working pressure, resulting in reduced energy consumption



## 5. High pressure air receiver

Compressed air demand typically fluctuates, during day and night, even minute to minute, second to second. Those fluctuations can cause switching losses in compressors. A properly sized compressed air receiver will deal with these short term fluctuations and will avoid potentially nervous switching of compressors. Thus it will contribute to the efficiency of your compressed air installation.

### Optimum Compression Technology

#### 4 stage compression : best of thermodynamics

When compressing air between 25 to 45 Bar, 4-stage compression with intercooling is the most energy efficient, it can also reduce energy costs up to 10% compared to three stage compression. While 4 stage compression may increase capital cost (CAPEX) it substantially reduces the energy cost and therefore lowers the operating cost of the equipment (OPEX). With the OPEX accounting for over 90% of the life cycle costs of the equipment, we believe our ZD hybrid 4 stage solution offers the best value for our customers.

## 6. High Pressure network

High pressure piping is extremely expensive; keep it as short as possible by mounting our (Z) **D** booster right next to the user you don't only eliminate costs but also pressure drops.

### Variable Speed Drive Technology

#### Up to 35% additional savings

Fixed speed machines are fine at full load but when air demand fluctuates, a Variable Speed Drive ensures substantial savings. Atlas Copco has pioneered the development of the integrated (VSD) variable speed drive compressor. We vary the speed of the driving motor with a frequency regulator, that determines the speed of the drive based upon the pressure. The big advantage is that you have the lowest pressure band regulation known in the compressor business resulting in high energy savings comparing to a standard load-unload regulation system. In the PET industry different bottle sizes require different volumes of air.



## Heat recovery for sustainable energy management

### Use your energy twice

Heat recovery forms part of a sustainable energy management strategy. With the adaptation of a heat recovery control unit, the energy recovered in the cooling water of your water cooled compressors can be used for several uses: boilers, warming of premises, showers, cleaning processes. This saves a lot of energy.

## Constant dry air at extreme low power consumption

### Save time and money

Thanks to their pioneering technology, our dryers ensure the lowest pressure drop and lowest energy consumption for the highest possible efficiency—saving you time and money throughout the production process. The uniqueness of the rotary drum dryers lies in the fact that the loss of compressed air is completely avoided. Due to the usage of the generated heat from the compression process, a minimal amount of power is required to achieve very low dewpoints.



## Monitoring and control

### How to get the most from the least

The Elektronikon® unit controller is specially designed to maximize the performance of your compressors and air treatment equipment under a variety of conditions. Our solutions provide you with key benefits such as increased energy efficiency, lower energy consumption, reduced maintenance times and less stress... less stress for both you and your entire air system.

## Evolving towards compressed air management

### SMARTLINK Service

A mouse-click reveals the online service log. Get quotes for parts and additional service quickly and easily.

### SMARTLINK Uptime

Uptime additionally sends you an e-mail or text message whenever a warning requires your attention.

### SMARTLINK Energy

Energy gives you customized reports on the energy efficiency of your compressor room, in compliance with ISO 50001.





# We value your investment

Our responsibility doesn't stop when the product is delivered. An extensive portfolio of exclusive aftermarket products and services is designed to add maximum value for our customers – no hidden costs, no surprises and minimized risk to your processes. Guaranteed serviceability within 24 hours ensures optimum availability and reliability of your compressed air systems with the lowest possible operating costs. We deliver this complete service guarantee through our extensive aftermarket organization, maintaining our position as the leader in compressed air.

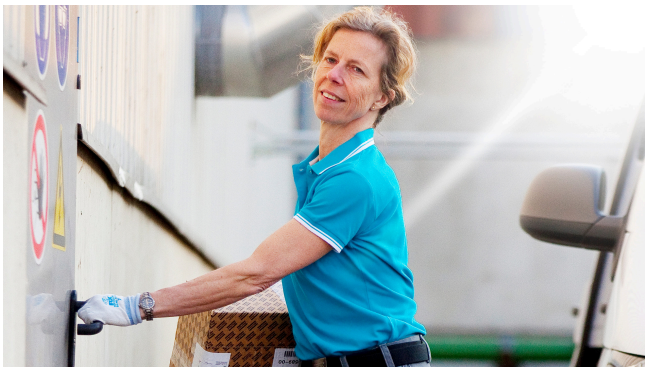

## Genuine parts

The Parts Plan delivers genuine Atlas Copco parts at your doorstep. Parts that are designed and produced to the exact specifications of your compressor. Our experts draw up a maintenance schedule based on your equipment and site conditions. Each delivery of parts triggers your technicians to perform the associated maintenance step.

Choose genuine parts to secure the performance of your air compressors.

Let the Parts Plan structure your maintenance activities and put an end to ad-hoc budgeting.

## Preventive maintenance

A Preventive Maintenance Plan offers on-time servicing by factory-trained Atlas Copco technicians, combined with the unrivalled quality of our genuine parts.

Tailored to your installation and site circumstances, the maintenance schedule always fits your needs, and gives you more uptime, better energy efficiency and increased reliability for a fixed periodic fee.

Step up your air compressor maintenance and go for optimal performance with maximum cost savings.



## Responsibility Plan

For an all-inclusive price, the Total Responsibility Plan is our commitment to take complete care of your compressor, with on-time maintenance by expert service engineers, genuine parts, proactive upgrades and improvements, and drive line overhauls. Best of all, it includes total risk coverage. This means we take care of all repairs, even breakdowns, without extra charges.

Give yourself the benefit of being able to focus on your production, while Atlas Copco takes Total Responsibility for your compressors.



ZD 800-4000 & ZD 1200-4100 VSD

# Ancillary equipment to safeguard overall reliability

A full range of accessories



## 40 bar filters

- Active carbon filter: Highly efficient dust filter up to 0.1 micron
- Oil vapor & odor removal filter: for filtration down to 0.005 mg/m<sup>3</sup>/ oil carry-over
- Both filters to be installed side-to-side

## Medium and High Pressure vessels for up to 45 bar

- volume 500-3000 liters (132/792 gallons)
- Safe design for applications up to 45 bar (653 psi)
- Hot dipped galvanized metallic tank

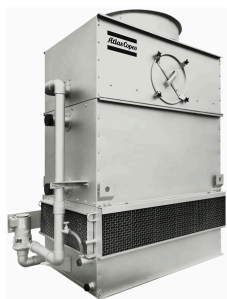

## Cooling tower

- Efficient cooling of closed loop water circuit
- Water savings with drift eliminators
- Maximum inlet water temperature 75°C 167°F

## Airblast cooling unit

- Efficient cooling of the closed loop water circuit
- Temperature approach : 5-15°C (41-59°F)
- Maximum water temperature : 70°C (158°F)



## Water pump skid

- Optimization of the flow in the compressor closed loop circuit
- Easy management: Groups all the functions for operation of the cooling unit or tower

## Energy Recovery

Electrical input is not the only source of energy entering the system. The suction air for the compressor contains water vapour. The heat stored in the vapour is released through condensation in the inter- and aftercooler of the compressor. Typically the condensation heat, contained in the suction air, is equivalent to 5-20% of the electrical input energy.



# Technical specifications

## ZD Premium (50 Hz)

ZD Premium 50Hz	Performance*			
	PDP (°C)	Pressure	Flow FAD (m <sup>3</sup> /h)	Motor power kW
ZD 800 FF	3	35	818	141
ZD 1000 FF	3	35	959	164
ZD 1200 FF	3	35	1195	206
ZD 1400 FF	3	35	1451	244
ZD 1600 FF	3	35	1606	272
ZD 2100 FF	3	35	2243	366
ZD 2500 FF	3	35	2462	405
ZD 2750 FF	3	35	2788	476
ZD 3050 FF	3	35	3006	499
ZD 3350 FF	3	35	3342	554
ZD 3750 FF	3	35	3846	661
ZD 4000 FF	3	35	4058	685

## ZD Premium (60 Hz)

ZD Premium 60Hz	Performance			
	PDP (°C)	Pressure	Flow FAD (m <sup>3</sup> /h)	Motor power kW
ZD 800 FF	3	35	872	152
ZD 1000 FF	3	35	1040	178
ZD 1200 FF	3	35	1148	196
ZD 1400 FF	3	35	1415	247
ZD 1600 FF	3	35	1656	279
ZD 1900 FF	3	35	1970	319
ZD 2300 FF	3	35	2304	378
ZD 2500 FF	3	35	2612	437
ZD 3100 FF	3	35	3053	508
ZD 3500 FF	3	35	3422	575
ZD 4000 FF	3	35	4002	688

# Technical specifications

## ZD Premium VSD (50 Hz)

ZD Premium VSD - 50Hz	Maximum performance				Minimum performance			
	PDP (°C)	Pressure	Flow FAD (m <sup>3</sup> /h)	Motor power kW	PDP (°C)	Pressure	Flow FAD (m <sup>3</sup> /h)	Motor power kW
ZD 1200 VSD FF	3	35	1151	204	3	35	491	90
ZD 1400 VSD FF	3	35	1378	249	3	35	491	91
ZD 2300 VSD FF	3	35	2252	388	3	35	1126	192
ZD 2800 VSD FF	3	35	2658	470	3	35	1123	192
ZD 3500 VSD FF	3	35	3522	592	3	35	1589	265
ZD 4100 VSD FF	3	35	3973	685	3	35	1589	264

## ZD Premium VSD (60 Hz)

ZD Premium VSD - 60Hz	Maximum performance				Minimum performance			
	PDP (°C)	Pressure	Flow FAD (m <sup>3</sup> /h)	Motor power kW	PDP (°C)	Pressure	Flow FAD (m <sup>3</sup> /h)	Motor power kW
ZD 1200 VSD FF	3	35	1151	204	3	35	491	90
ZD 1400 VSD FF	3	35	1378	249	3	35	491	91
ZD 2300 VSD FF	3	35	2252	388	3	35	1126	192
ZD 2800 VSD FF	3	35	2658	470	3	35	1123	192
ZD 3500 VSD FF	3	35	3522	592	3	35	1589	265
ZD 4100 VSD FF	3	35	3973	685	3	35	1589	264

\* At reference conditions and according to ISO 1217.

**Reference conditions:**

- Inlet pressure: 1 bar(a)
- Relative air humidity: 0%
- Air inlet temperature: 20°C
- Cooling water inlet temperature: 20°C
- Nominal effective working pressure: 35 bar



