



Atlas Copco



Driving Centrifugal
Compressor Technology

Atlas Copco Gas and Process Solutions
HANDLE THE PRESSURE

HANDLE THE PRESSURE

We know you're no stranger to pressure.
Budget pressure. Time pressure. Performance pressure.

Pressure challenges us, but it also pushes us to be better. At **Atlas Copco Gas and Process**, the pressures you face are what drive us to develop turbomachinery that assures reliability, improves efficiency and reduces cost. To us, pressure is innovation in progress.



CONTENTS

Turbocompressor overview	04
Markets served	06
Inside integral-gear technology	08
Inside multi-stage single-shaft technology	10
Inside single-stage single-shaft technology	12
Gears	14
Impellers	16
IGVs	18
vDGVs	20
Seals	22
Bearings	24
Compander	26
Standardized compressors	27
Product matrix	28
Engineering expertise	30
Production cycle	31
Frequently asked questions	32

ADVANCED COMPRESSOR SOLUTIONS FOR YOUR CRITICAL DEMANDS

Over the past few decades, Atlas Copco Gas and Process has built close relationships with customers around the globe. In doing so, we have pursued one goal: providing our customers with sustainable productivity — regardless of process, application or market.



Supporting you every step of the way

There's no time for downtime. That's why critical applications in more than 180 countries rely on Atlas Copco Gas and Process' industry-leading turbomachinery technology to keep them up and running around the clock. Our broad range of centrifugal compressors, including both integrally geared and non-g geared designs, provides innovative ways to handle the pressures you face every day.

Get the flexibility you need for all your processes with our fully customizable compressor solutions and standardized designs for low-CAPEX, fastturnaround projects. Our standardized compressors include customizable aerodynamics to optimize performance and provide maximum efficiency. From project concept through commissioning — and beyond — Atlas Copco Gas and Process is here to support you every step of the way.

Our compressor range

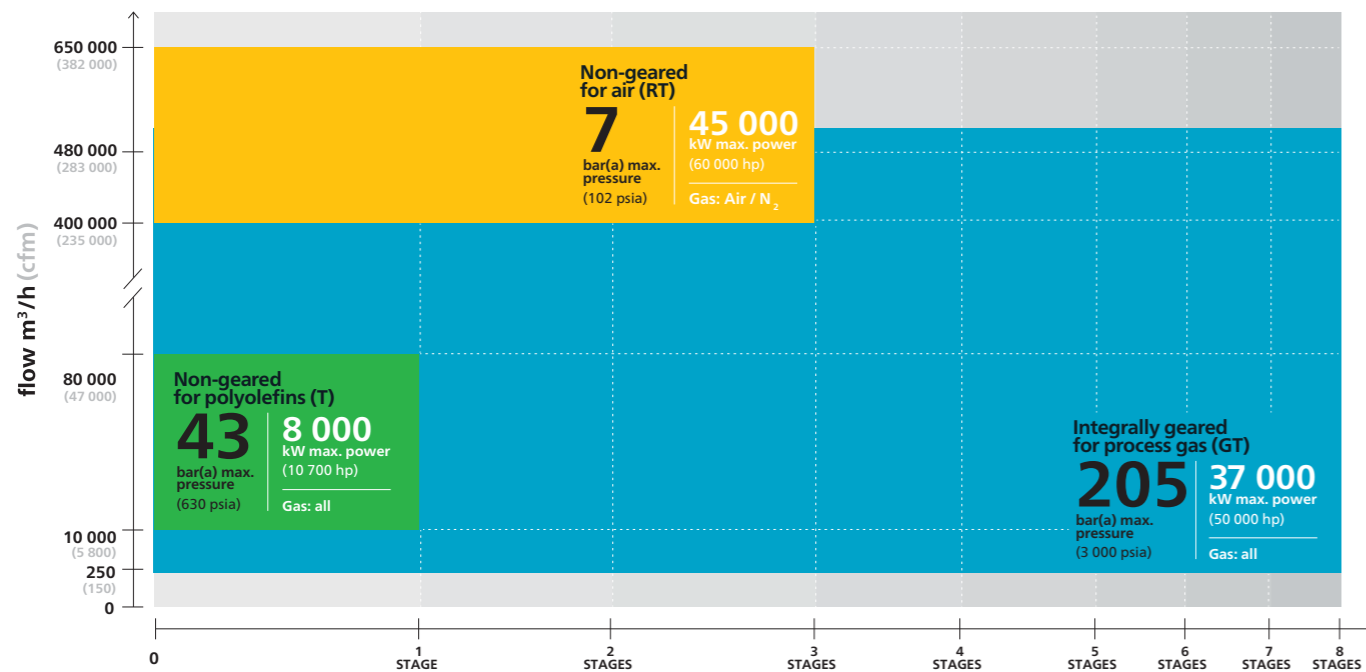

ATLAS COPCO GAS AND PROCESS

Reliability & availability

99%

8 000 + MACHINES

running in process gas applications worldwide. With 99.8% reliability and 99.7% availability, our centrifugal compressors are the industry's most trusted.

Flexibility & efficiency



10–15%

efficiency increase, thanks to exceptional design and state-of-the-art process cooling capability, as well as process flexibility shown in our Comander combined service and multi-section compressors.

Custom aero, standard package















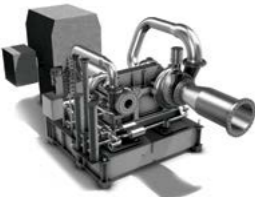

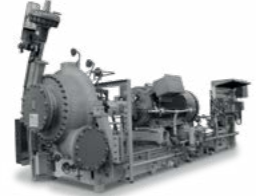







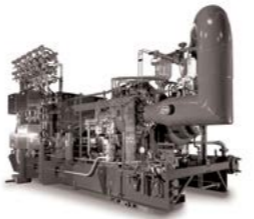





CAPEX & OPEX

savings with our standardized solutions that offer optimized aerodynamics and pre-engineered package components.

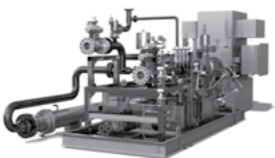
ATLAS COPCO GAS AND PROCESS CENTRIFUGAL COMPRESSORS, THE PERFECT FIT FOR YOUR PROCESS

Our integrally-geared GT-series compressors and radial single-shaft T- and RT-series compressors cover a wide range of applications, across many important markets. From gas processing and LNG to petrochemicals, supercritical power cycles and beyond, our compressors provide the most efficient, space-saving and reliable solutions.

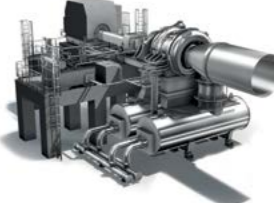
This product showcase is only a portion of our total compressor product line and just a few of the numerous applications it covers.

Hydrocarbon Processing				Hydrocarbon Processing		Power Generation	Industrial Gases
Gas Processing	LNG	Olefins / Polyolefins	Syngas / Methanol	Refineries	Fertilizer		
 <p>Refrigeration gas – GT-series</p>  <p>Residue gas – GT-series</p>  <p>Regeneration gas – GT-series</p> 	 <p>Boil off gas / Large scale and CLNG – GT-series</p>  <p>Reliquefaction – Comander</p>  <p>Mixed refrigerant / SSLNG – GT-series</p> 	 <p>Cycle / Recirculation gas – PolyBlock™</p>  <p>Recycle gas – GT-series</p>  <p>Propylene oxide production (HPPO) – Comander</p> 	 <p>Refrigeration gas – GT-series</p>  <p>Syngas - GT-series</p>  <p>Regeneration gas – GT-series</p> 	 <p>Refrigeration gas – GT-series</p>  <p>PSA tailgas – GT-series</p>  <p>Flue gas desulphurization – GT-series</p> 	 <p>CO₂ – GT-series</p>  <p>Nitric acid – Comander</p> 	 <p>Fuel gas boosting – GT-series, TurboBlock™</p>  <p>Supercritical CO₂ power cycle – GT-series</p> 	 <p>Main air – GT-series, AeroBlock™</p>  <p>Main air – RT-series</p>  <p>Carbon monoxide / HyCO plants</p> 

See what we can do for your process.

Contact an Atlas Copco Gas and Process product specialist at: www.atlascopco-gap.com/contacts

See how our centrifugal compressors can bring more efficiency, reliability and performance to your compression processes.

GIVE YOUR PROCESS A CLEAR ADVANTAGE WITH INTEGRAL GEARING

As the industry's most efficient and compact compressor design, integral gear technology is the go-to solution for numerous applications. Through its optimized aerodynamics, superb process control and interstage cooling capabilities, integral gearing provides the efficiency, reliability and performance that are vital to your process.

INTEGRALLY-GEARED COMPRESSORS – GT-SERIES

Integrally-geared compressor features

- Higher efficiency versus other rotating compression technologies
- Compact design saves space and simplifies transport and setup
- Multi-speed capability for optimal performance at each stage
- Optional interstage cooling for boosting isothermal efficiency
- Improved process flexibility handling different process gases via combined service and multi-section
- Easy access for inspection and maintenance

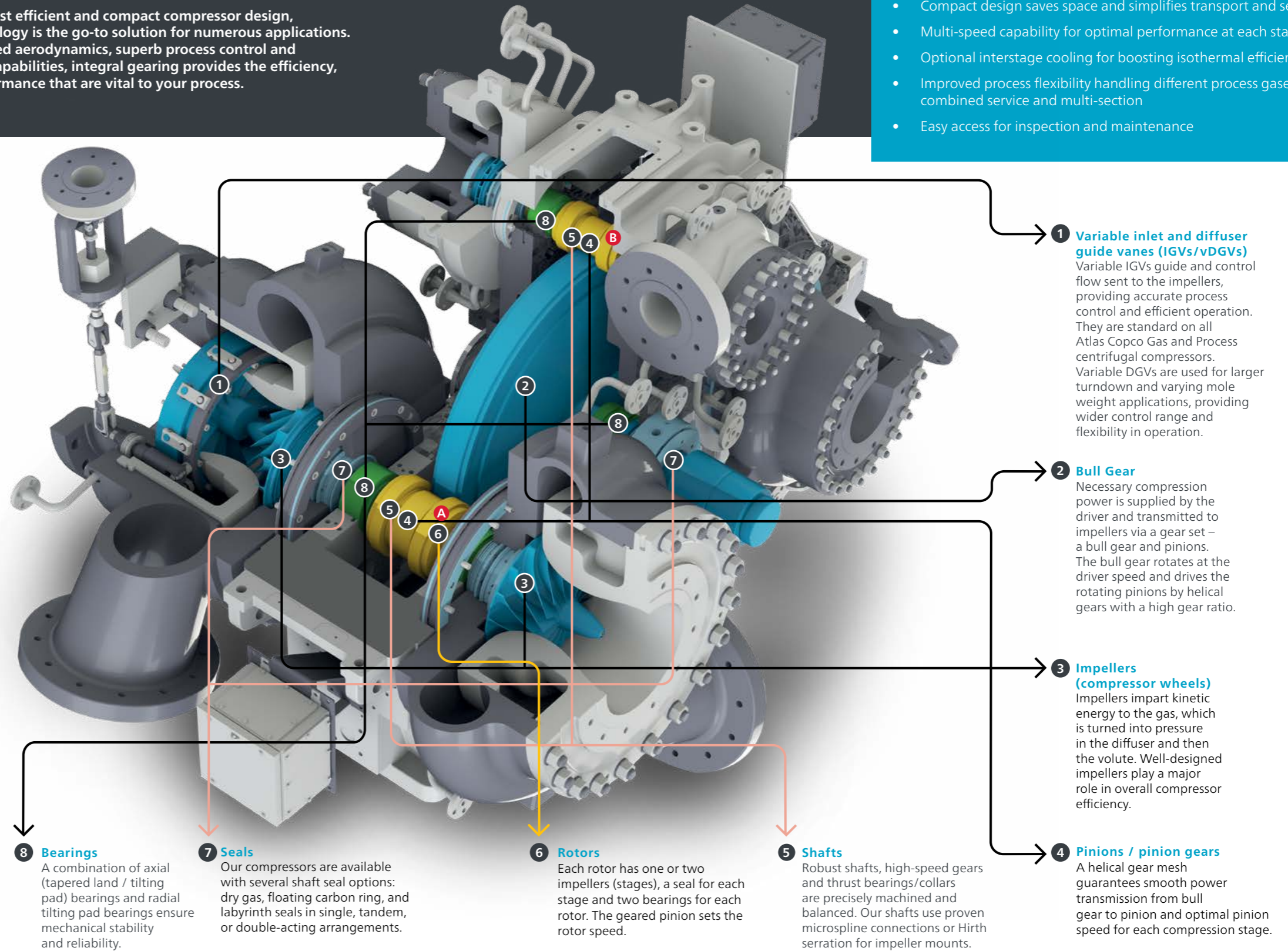

Integral gearing basics

- 1) As the name suggests, in integrally geared compressors (IGCs) multiple compressor stages are mounted onto one gearbox.
- 2) A driver, such as a motor, is coupled to a bull gear that drives several pinions. Integrally geared compressors deliver multiple-speed capability by placing impellers on separate pinions (A, B).
- 3) Each compression stage runs at the optimum speed for high efficiency.
- 4) The optimal aerodynamic performance that IGCs can obtain at each stage translates into higher per-stage pressure ratios. The result is that fewer compression stages are necessary to reach a target outlet pressure.

Optional interstage cooling

Gas temperature rises during the compression process. To improve compression efficiency, interstage cooling can be easily accommodated between any of the compressor stages.

To control gas temperatures, we can supply coolers and aftercoolers. Water-cooled or air-cooled interstage

8 Bearings

A combination of axial (tapered land / tilting pad) bearings and radial tilting pad bearings ensure mechanical stability and reliability.

7 Seals

Our compressors are available with several shaft seal options: dry gas, floating carbon ring, and labyrinth seals in single, tandem, or double-acting arrangements.

6 Rotors

Each rotor has one or two impellers (stages), a seal for each stage and two bearings for each rotor. The geared pinion sets the rotor speed.

5 Shafts

Robust shafts, high-speed gears and thrust bearings/collars are precisely machined and balanced. Our shafts use proven microspline connections or Hirth serration for impeller mounts.

1 Variable inlet and diffuser guide vanes (IGVs/vDGVs)

Variable IGVs guide and control flow sent to the impellers, providing accurate process control and efficient operation. They are standard on all Atlas Copco Gas and Process centrifugal compressors. Variable DGVs are used for larger turndown and varying mole weight applications, providing wider control range and flexibility in operation.

2 Bull Gear

Necessary compression power is supplied by the driver and transmitted to impellers via a gear set – a bull gear and pinions. The bull gear rotates at the driver speed and drives the rotating pinions by helical gears with a high gear ratio.

3 Impellers (compressor wheels)

Impellers impart kinetic energy to the gas, which is turned into pressure in the diffuser and then the volute. Well-designed impellers play a major role in overall compressor efficiency.

4 Pinions / pinion gears

A helical gear mesh guarantees smooth power transmission from bull gear to pinion and optimal pinion speed for each compression stage.

OUR ROBUST SINGLE-SHAFT MULTI-STAGE DESIGN

To provide high flow capability, our single-shaft centrifugal air compressor is built on a sturdy frame with proven compressor stage aerodynamics and interstage cooling. Designed for higher capacity, the single-shaft compressor is tailored to the needs of the air separation industry for efficiency, higher reliability, minimal maintenance and faster installation.

Drive train flexibility

Single-shaft RT-Series compressors represent our unique solution for the highly demanding industrial air market. They are compatible with single or double-ended steam turbine and can be coupled with a multi-stage booster (air or nitrogen) compressor.

Atlas Copco Gas and Process solutions are engineered to our customers' needs, assuring reliable installation and optimal performance for the entire compression train.

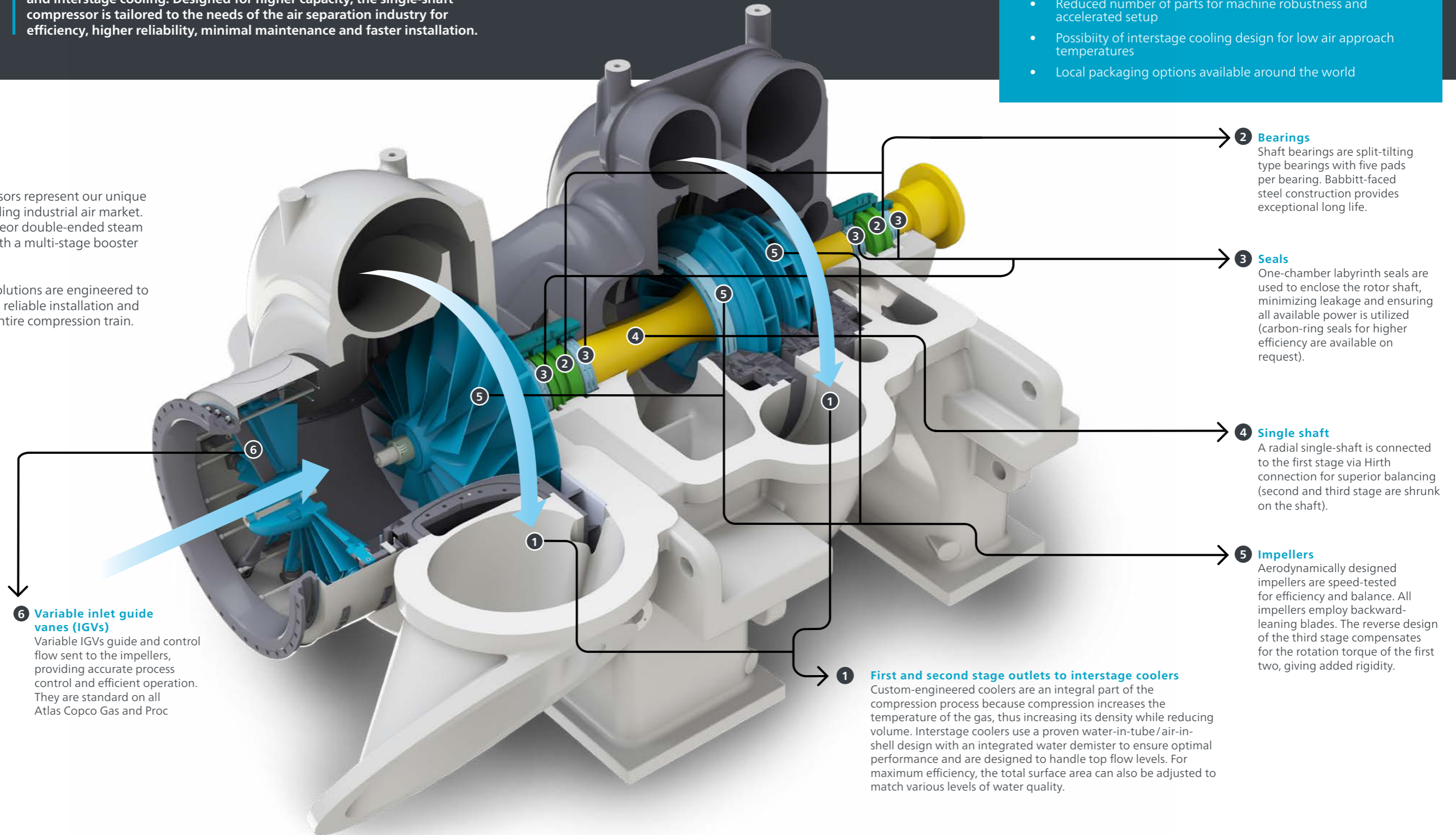

6 Variable inlet guide vanes (IGVs)
Variable IGVs guide and control flow sent to the impellers, providing accurate process control and efficient operation. They are standard on all Atlas Copco Gas and Proc

1 First and second stage outlets to interstage coolers
Custom-engineered coolers are an integral part of the compression process because compression increases the temperature of the gas, thus increasing its density while reducing volume. Interstage coolers use a proven water-in-tube/air-in-shell design with an integrated water demister to ensure optimal performance and are designed to handle top flow levels. For maximum efficiency, the total surface area can also be adjusted to match various levels of water quality.

4 Single shaft
A radial single-shaft is connected to the first stage via Hirth connection for superior balancing (second and third stage are shrunk on the shaft).

5 Impellers
Aerodynamically designed impellers are speed-tested for efficiency and balance. All impellers employ backward-leaning blades. The reverse design of the third stage compensates for the rotation torque of the first two, giving added rigidity.

3 Seals
One-chamber labyrinth seals are used to enclose the rotor shaft, minimizing leakage and ensuring all available power is utilized (carbon-ring seals for higher efficiency are available on request).

2 Bearings
Shaft bearings are split-tilting type bearings with five pads per bearing. Babbitt-faced steel construction provides exceptional long life.

SINGLE-SHAFT COMPRESSORS – RT-SERIES

Single-shaft compressor features

- Efficient impeller and stage design for excellent performance
- Proven modular design for all components
- Reduced number of parts for machine robustness and accelerated setup
- Possibility of interstage cooling design for low air approach temperatures
- Local packaging options available around the world

SIMPLE CONCEPTS FOR SUPERIOR PROCESS RELIABILITY

Our single-shaft PolyBlock™ unlocks a high level of aerodynamic performance. The entire compressor stage is designed to prevent polymerization in the machine to ensure process reliability and availability.

Proven maintainability concepts

With its proven design features and maintainability concepts, Atlas Copco Gas and Process T-series compressors are the right match for the challenging requirements in your polyolefin plant.

Our smart plug-in design for direct-driven compressors enables easy access to all rotating parts such as dry face seals, impellers, bearings or vibration probes. For maintenance, the bearing carrier can be pulled from the back. In turn, this ensures a maximum level of compressor maintainability, and ultimately improves the availability of your overall plant.

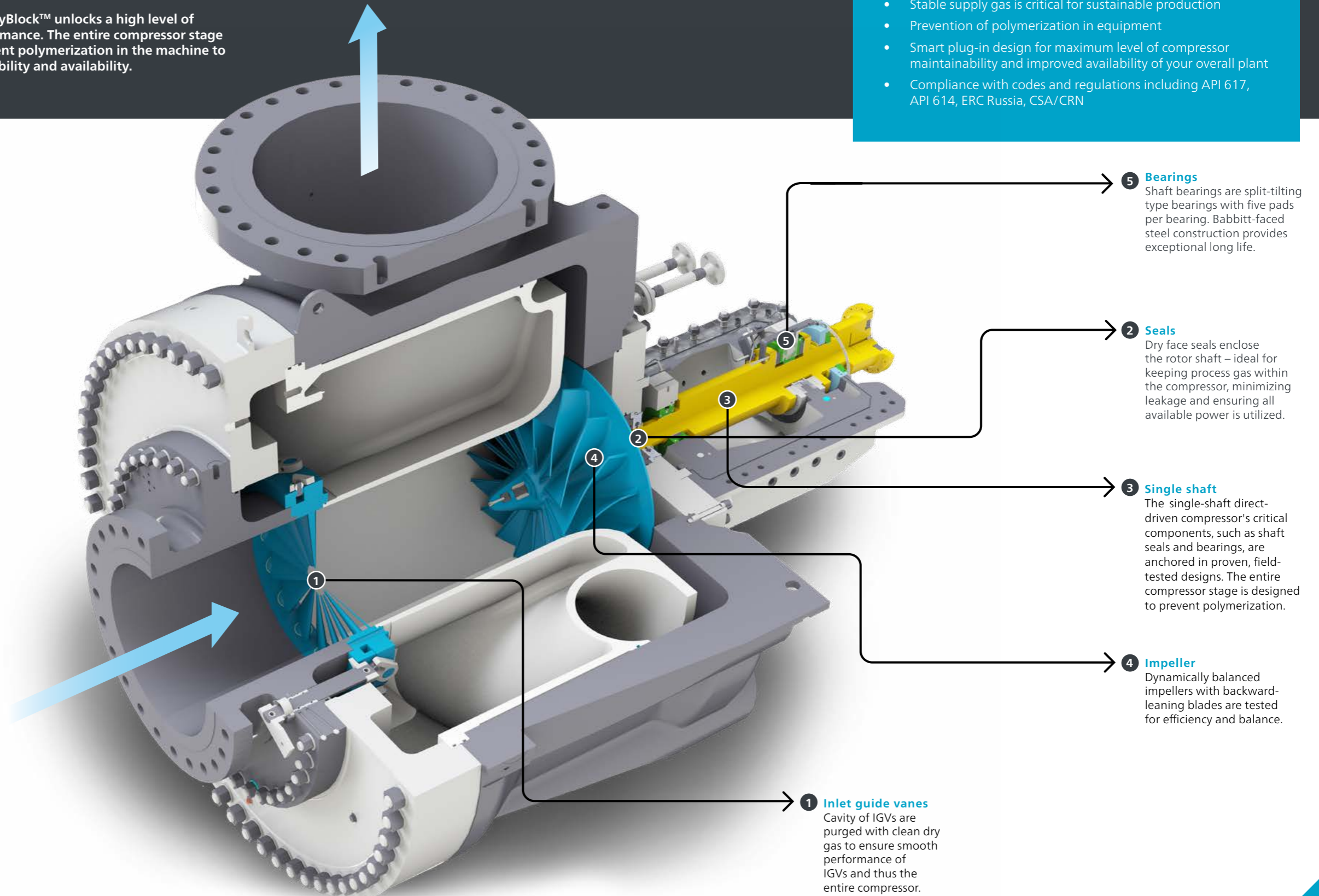

1 Inlet guide vanes
Cavity of IGVs are purged with clean dry gas to ensure smooth performance of IGVs and thus the entire compressor.

4 Impeller
Dynamically balanced impellers with backward-leaning blades are tested for efficiency and balance.

3 Single shaft
The single-shaft direct-driven compressor's critical components, such as shaft seals and bearings, are anchored in proven, field-tested designs. The entire compressor stage is designed to prevent polymerization.

2 Seals
Dry face seals enclose the rotor shaft – ideal for keeping process gas within the compressor, minimizing leakage and ensuring all available power is utilized.

5 Bearings
Shaft bearings are split-tilting type bearings with five pads per bearing. Babbitt-faced steel construction provides exceptional long life.

SINGLE-SHAFT COMPRESSORS – POLYBLOCK™

Single-shaft compressor benefits

- Maximum compressor efficiency and robustness in complex and rigid polyolefin processes
- Stable supply gas is critical for sustainable production
- Prevention of polymerization in equipment
- Smart plug-in design for maximum level of compressor maintainability and improved availability of your overall plant
- Compliance with codes and regulations including API 617, API 614, ERC Russia, CSA/CRN

GEARS: THE INTEGRAL ADVANTAGE

No other rotary compressor design can provide integrally geared compressors' unmatched performance and customization. Integral gearing enables compressors to get the most from compression aerodynamics at every stage – delivering superior efficiency and energy savings.

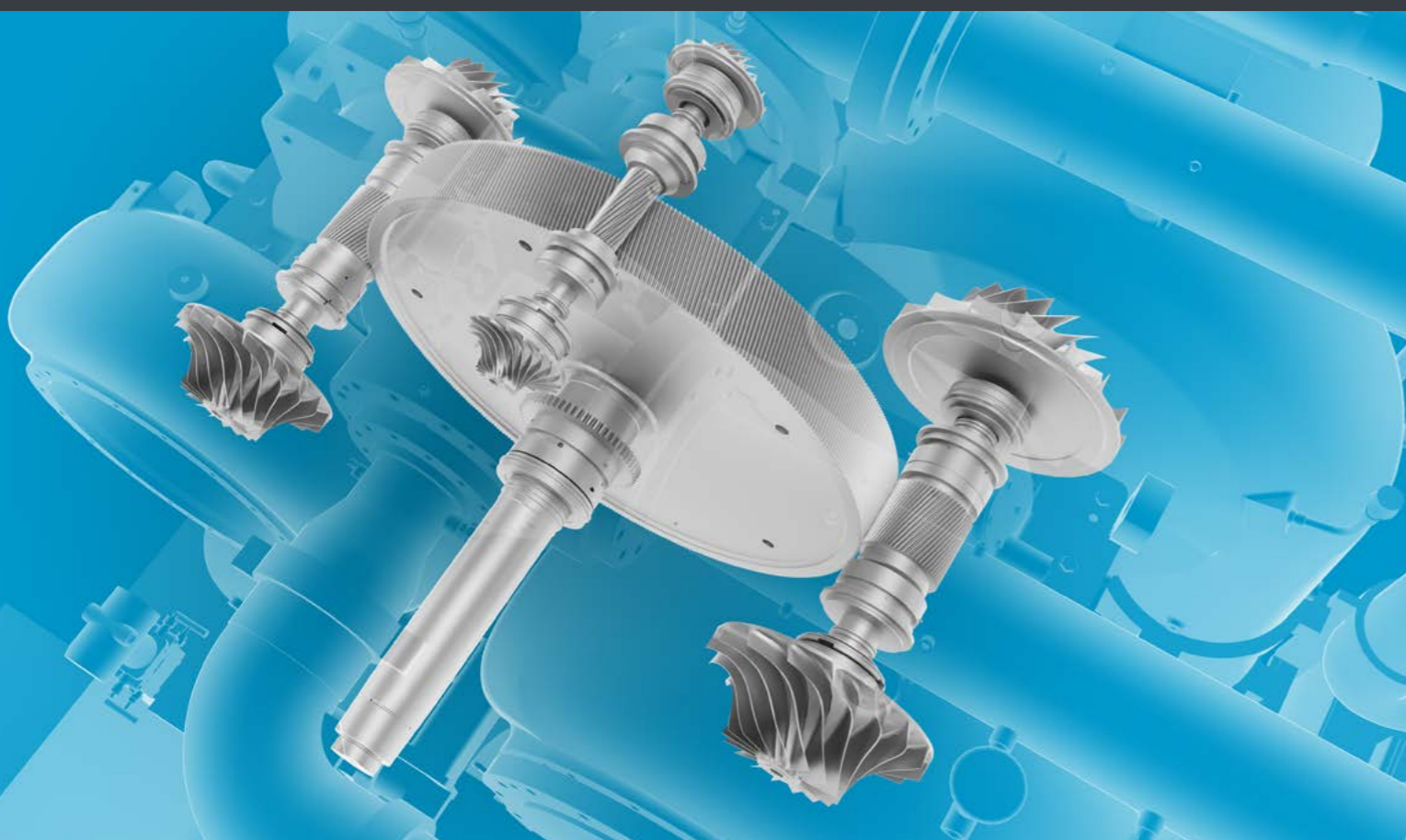

GEARBOX TECHNICAL HIGHLIGHTS

Forged or hot-rolled alloy steel shafts

- One-piece pinion forgings
- Forged bull gear, interference fit to shaft
- Gear rating methodology differentiated by gear ratio:
 - Below 7:1 - API 613
 - Above 7:1 - AGMA 2101 / ISO 1940 modified for material and gear grinding quality to achieve reliability consistent with API 613
 - Ratings based on twenty-year life and API service factor
- Easy access for inspection and maintenance

Performance without compromise

One of integral gearing's main advantages is its flexibility. By running each stage group off an independent pinion and utilizing gear ratios between a main bull gear and pinions, each compression stages is individually set for optimal aerodynamics.

This means that the greatest amount of compression can be created for the least amount of energy.

At the same time, integral gearing offers a space-saving, compact footprint while still allowing easy access for inspection and maintenance.

INTEGRAL GEAR TECHNOLOGY BENEFITS

- Four high-speed pinions (up to 8 stages) with optimum individual speed
- Multi- and combined service on the same gearbox
- Can be combined with hot or cold gas turboexpander
- Flexible drive options including electric motor, steam or gas turbine
- Simple accommodation of intercooling between each of the stages
- Compact footprint
- Easy access for inspection and maintenance

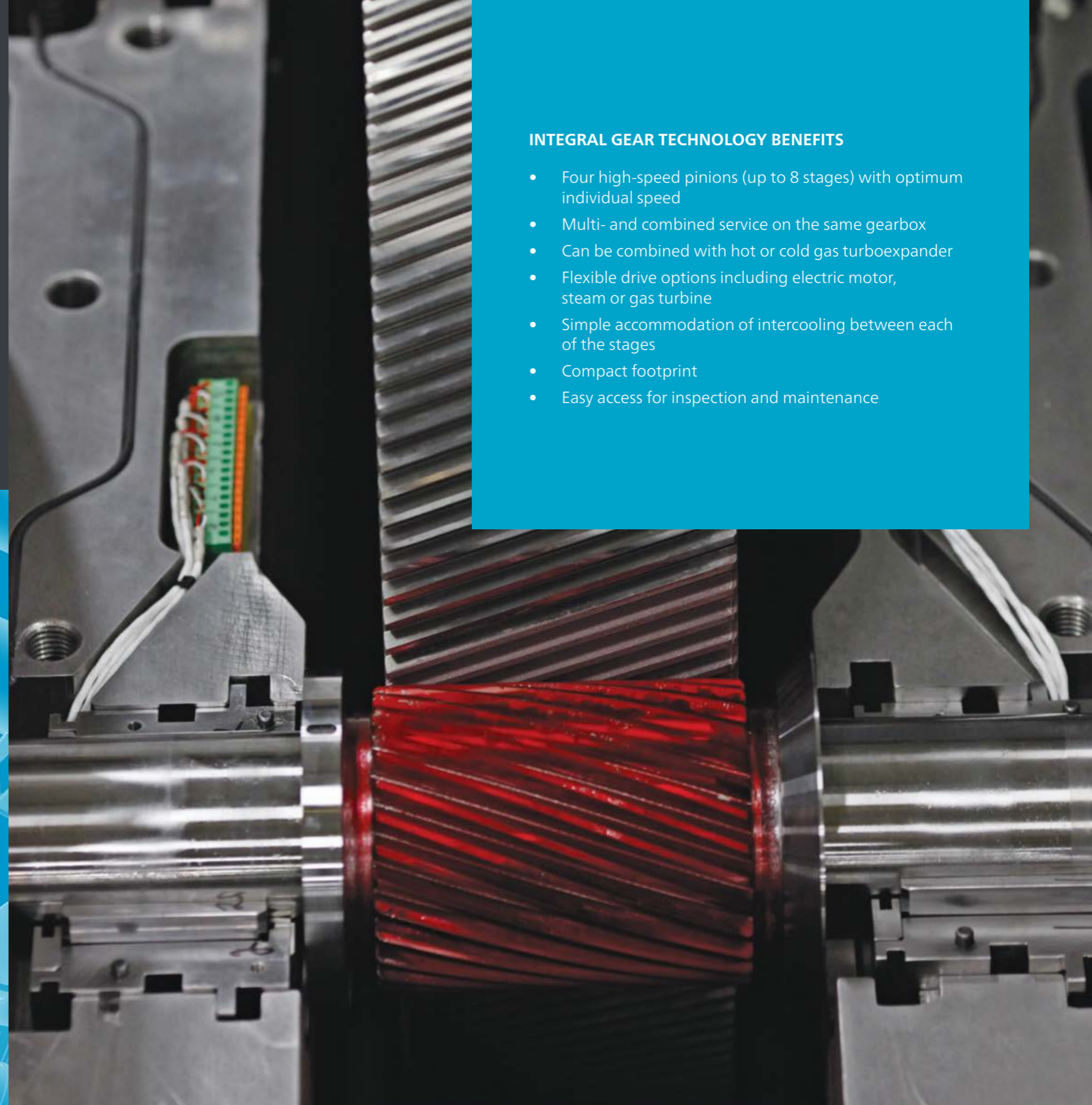

Did you know?

High power: booster air compressor Steel plant, China

Our largest main air compressor weighs 800 tons and has a powerful 29 MW drive (39 000 HP).

Inlet pressure	0.99 bar (a) (14.4 psia)
Outlet pressure	6.4 bar (a) (92.8 psia)
Flow	380 000 m ³ /h (220 000 cfm)
Inlet temperature	30 °C (86 °F)
Driver power	29 MW (39 000 hp)

High RPMs: pipeline compressor Natural gas pipeline, Poland

Thanks to integral gearing, a pipeline sendout gas compressor produces pinion speeds of over 45 000 RPM.

Inlet pressure	6.3 bar (a) (91 psia)
Outlet pressure	38.9 bar (a) (564.2 psia)
Flow	2 516 m ³ /h (1 480 cfm)
Inlet temperature	37.5 °C (99.5 °F)
Driver power	3 000 rpm
Max. machine speed	45 682 rpm

IMPELLERS: AERODYNAMICS IN ACTION

Impellers run at the heart of centrifugal compressors, creating both pressure and flow. Through the experience of building thousands of compressor stages and the latest computer design tools, Atlas Copco Gas and Process delivers impellers to meet your exact flow and pressure requirements while offering high efficiency and a wide control range.

Proven, efficient impeller designs

A centrifugal compressor can only deliver high efficiency and a wide flow range if its impellers can. That is precisely where our experience comes into play. Over more than seven decades we've developed a vast database of impeller designs, and we have extensive knowledge in custom designs for specific gases and applications.

We use the latest computational-fluid dynamic (CFD) and finite-element analysis (FEA) to design our impellers and they are milled with the latest five-axis, computer-aided manufacturing processes.

Our performance-tested impellers include all standard 2D and 3D geometries in both shrouded and open configurations, reaching over 1.700 m.

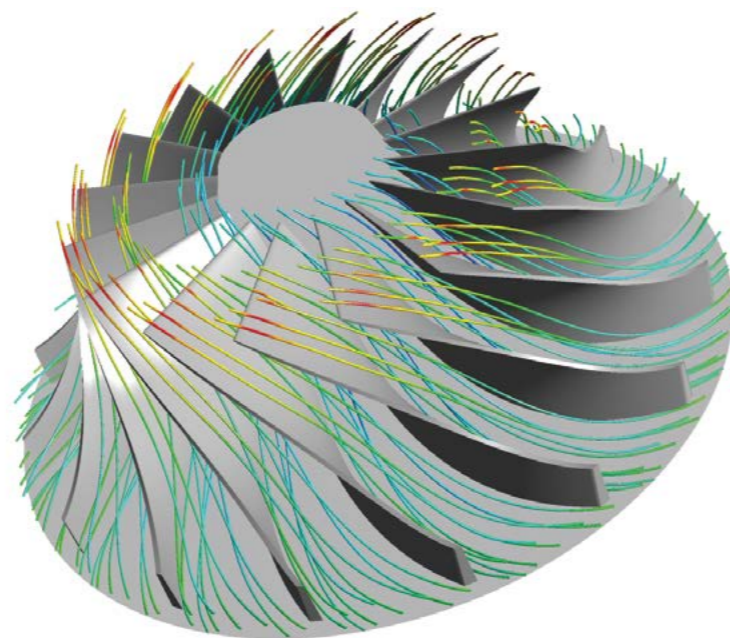

An aerodynamic impeller calculation in CFD

IMPELLER TECHNICAL HIGHLIGHTS

- Geometries include 45°, 50°, 65° and 90° in either open or closed configurations
- Precision stainless steel or milled from solid forging, depending on application requirements
- Standard material is X3CrNiMo (1.4313) or Armco 15-5 PH; other materials are Aluminium 2618 or Titanium 6061
- A full range of 2D and 3D designs
- Each impeller is dynamically balanced, as well as overspeed and ring tested before assembly
- Closed impeller designs are produced as an integral single piece, precision welded, or via high temperature vacuum brazing



IMPELLER DESIGN BENEFITS

- Optimum efficiency and reliability
- Strong track record for use with corrosive and other challenging gases
- Individually selected for your process requirements
- Performance tested
- Covers a broad range of applications and processes
- Employs latest CFD design and five-axis milling machine manufacturing

Did you know?

High flow: RT-series main air compressor Air separation for refinery processes, China

Our single-shaft RT compressor delivers high air flow levels for main air units at urea plants and in a number of other processes such as GTL.

Inlet pressure	1.01 bar (a) /14.6 (atmospheric)
Outlet pressure	up to 7 bar(a) (102 psia)
Flow	650 000 m ³ / h (382 500 cfm)
Inlet temperature	-29 to 50 °C (-20 to 122 °F)
Power	60 000 hp (45 000 kW)
Max. machine speed	6 000 rpm

High inlet Mach number: three-stage GT-series Natural gas refinery, Oklahoma, USA

In this three-section hydrocarbon compressor our designs have exceeded inlet Mach No 1.2.

Inlet pressure	1.2 bar (a) (17 psia)
Outlet pressure	51 bar (a) (740 psia)
Flow	8 840 m ³ / h (5 200 cfm)
Inlet temperature	36.2 °C (97.2 °F)
Power	33 848 rpm
Highest stage Mach number	1.2

IGVs: DELIVERING SUPERIOR EFFICIENCY

Variable inlet guide vanes (IGVs) are a proven option for centrifugal compressors that can reduce energy use and give greater control over the compressor's operating range. They are part of a full range of capacity-control options that ensure your process is as flexible and efficient as possible.

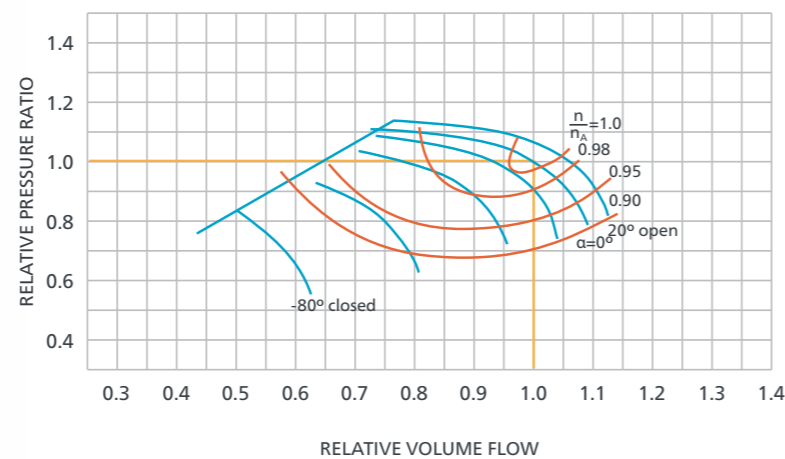

Complete process control through IGVs

Energy consumption represents about 80% of a total compressor's lifecycle costs. So, energy savings can have a big result on the bottom line.

Inlet guide vanes help reduce these energy costs by creating an initial pre-swirl flow pattern that is matched to the impeller, improving compressor efficiency and reducing the amount of power required for compression. At the same time, they act as an efficient throttling device that ensures your compressor is delivering optimal performance during non-design point operation, typically the majority of a compressor's service life.

They provide accurate process control and maintain efficient operation over a wide range of flow levels.

BENEFITS OF VARIABLE INLET GUIDE VANES

- A typical energy savings of 9% versus butterfly valves and other throttling methods
- Excellent partial load performance
- Wide operating range, typically 75% to 105% of design flow
- Available on all stages for multistage compressors
- Avoids more pronounced pressure drops caused by suction throttling
- Perfect for applications that often operate below design point



Did you know?

Combined service: ammonia compressor Fertilizer plant in the Netherlands

At a fertilizer plant, this machine compresses CO₂ over four stages and ammonia across two separate stages using one drive.

Inlet pressure (section one)	1.1 bar (a) (16 psia)
Inlet pressure (section two)	1.6 bar (a) (23.2 psia)
Outlet pressure (section one)	22 bar (a) (319 psia)
Outlet pressure (section two)	3.0 bar (a) (43.5 psia)
Flow (section one)	7 270 m ³ /h (4 279 cfm)
Flow (section two)	2 810 m ³ /h (1 654 cfm)
Power consumption	1.5 MW (2 000 hp)

Two-stage FGB w/ IGVs and throttle valve Over 400 FGB units around the globe

This fuel gas booster incorporates IGV control with two throttle valves to operate over the large mole weight swing.

Inlet pressure	10 bar (a) (145 psia)
Outlet pressure	36 bar (a) (522.1 psia)
Flow	59 508 kg/h (131 192.5 lb/h)
Inlet temperature	12.7 – 47°C (54.9 – 116.6°F)
Power	3 780 – 4 270 kW (5 070 – 5 726 hp)

vDGVS: KEEPING THE PRESSURE CONSTANT WITH LARGER TURNDOWN

Similar to IGVs, but regulating compressor discharge instead of in flow, variable diffuser guide vanes (vDGVs) extend compressor turndown up to 50%, adapting to changing process conditions. They can be employed to maintain a required outlet pressure, which gives greater flexibility for operations with varying mole weight and head requirement.



Variable inlet and diffuser guide vanes

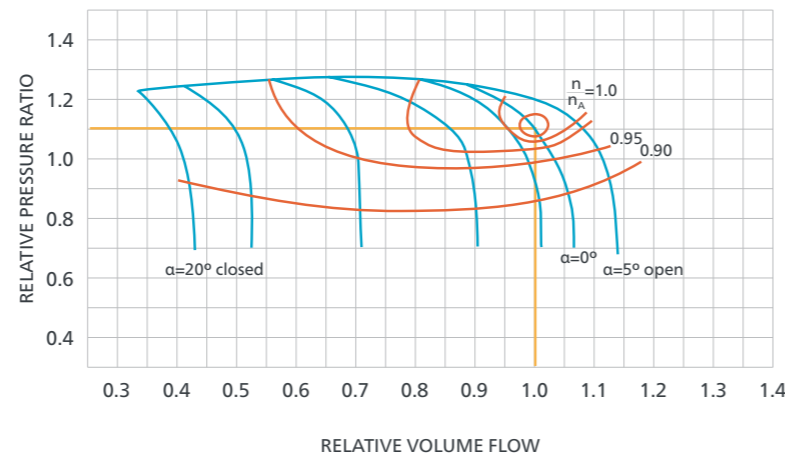

Additional control options with vDGVs

Centrifugal compressors may be equipped with variable diffuser guide vanes (vDGVs) to boost turndown and ensure an excellent control range in both single and multi-stage applications. They help maintain high efficiency at a relatively constant discharge pressure.

Diffuser vanes are adjustable, flow optimized, non-symmetrical airfoils that are placed in a group around the impeller.

By opening wider or closing, they influence the aerodynamics, which allows a wider operating range. This may be done to increase headrange at a particular flow and alter possible surge points. This can be an extra protection for applications that might see more intermittent operation or short peak volume periods.

Variable diffuser guide vanes also provide an excellent solution for start-up during high settle-out conditions, like those in refrigeration processes.

BENEFITS OF VARIABLE DIFFUSER GUIDE VANES

- Wide control range with high efficiency at a constant head
- Large operating range, typically 45% to 105% versus design value
- Installed on all compressor stages; can be combined with IGVs
- A good choice for applications with considerable changes in head requirement
- An efficient way to increase compressor surge limit to give additional process control
- Recommended for constant pressure ratio control on high-Mach number compressor applications



Did you know?

Multi-services: refrigeration compressor NGL Fractionation, Saskatchewan, Canada

This multi-section compressor enables convenient and compact fractionation of NGLs through a deethanizer, a depropanizer and a debutanizer.

Inlet pressure	2.41 bar (a) / 5.2 (bar (a) / 17 bar (a) (multiple services) (34.95 psia) / (75.4 psia) / (246.6 psia)
Outlet pressure	5.45 bar (a) / 17.4 bar (a) / 35.5 bar (a) (79 psia) / (252.4 psia) / (514.9psia)
Flow	18 872 m ³ /h / 12 412 m ³ /h / 4 582 m ³ /h (11 108 cfm) / (7 305 cfm) / (2 697 cfm)
Inlet temperature	19.3 / 11.6 / 59.7 °C (-2.7 / 52.9 / 139.5 °F)
Power	6 860 kW (9 200 hp)

IGV/DGV pairing: residue gas compressor Offshore platform, Alaska, USA

This compressor is equipped with IGVs on the first stage and DGVs on all stages for efficient residue gas compression and sendout in extreme environmental conditions.

Inlet pressure	1.2 bar (a) (17.4 psia)
Outlet pressure	17 bar (a) (246.6 psia)
Flow	125 580 m ³ /h (73 914 cfm)
Inlet temperature	-28 °C (-18.4 °F)
Power	8 090 kW (10 850 hp)

SEALS: MINIMIZING LEAKAGE TO KEEP PROCESS GAS WITHIN THE SYSTEM

For challenging expensive, corrosive, or toxic process gases, leakage is not an option. Our compressors are available with a range of state-of-the-art seals. Because every application requires a different solution, we offer a wide variety of seals with options matched precisely to your specific requirements.

The perfect fit for your application

Our sealing options include dry gas, floating carbon ring, and labyrinth seals. All are designed to provide one universal advantage: process safety.

Drawing on decades of engineering experience, our experts will gladly help you identify the seal type that meets your precise process needs.

Dry gas seals virtually eliminate gas leakage

Whether you are dealing with a flammable gas mixture, high-pressure CO₂ or a toxic cyanide, process gas needs to remain in the machine. It is not only important for plant safety, it can influence process efficiency and performance. Our dry gas seals are just the answer.

They can be applied in single, tandem or double configurations for absolute tightness. The seals meet the API 614/617 standard, and are referenced over wide range of applications, gases and pressures.

Carbon ring seals for harshest conditions

When extreme process conditions might prohibit the use of an alternative sealing method – especially with cryogenic or hot gases – our carbon ring seal solutions present a cost-effective and reliable solution.

We can combine carbon rings seals with two to five chambers for buffer gas and they may be used as a primary or process seal. They can also be employed as tertiary seals or barrier seals to prevent lube oil contamination into secondary seals.

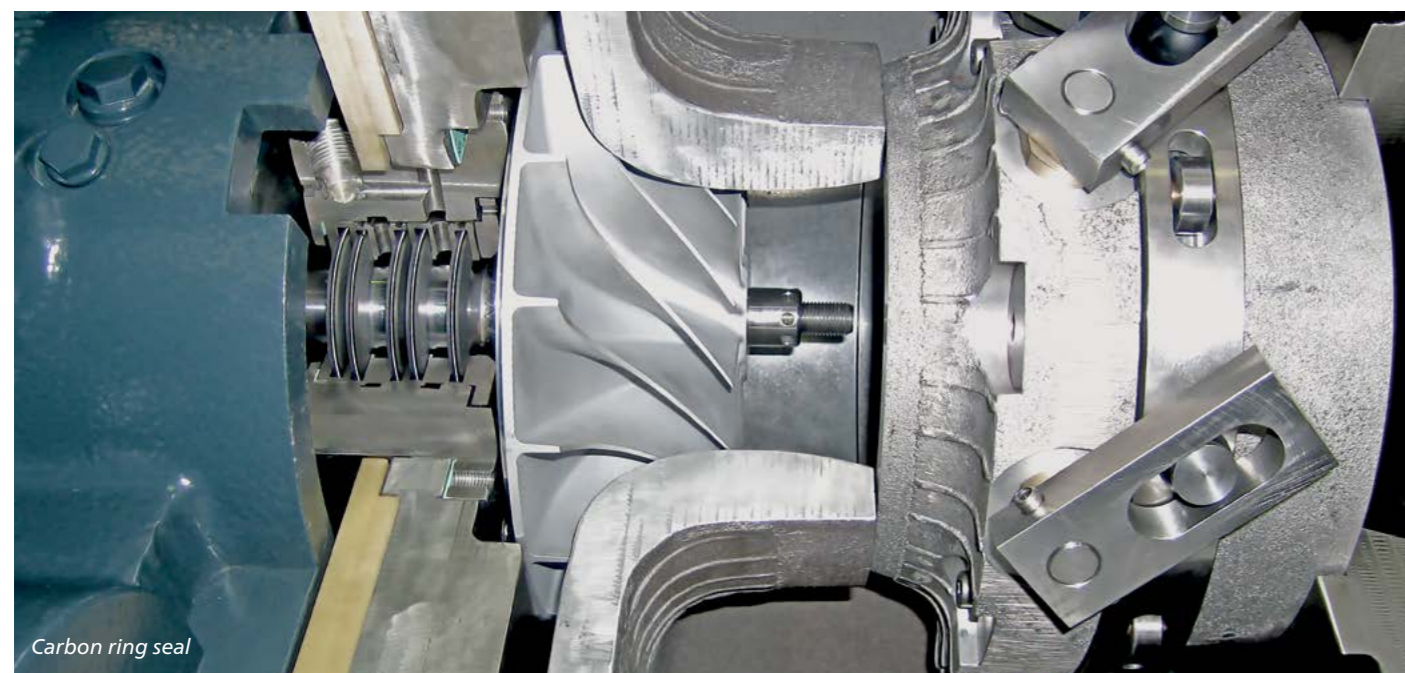

Carbon ring seal



SEAL SOLUTION BENEFITS

- Minimize or eliminate gas leakage
- Superior reliability
- Options include: dry-gas, floating carbon ring, oil-lubricated and labyrinth seals
- Referenced over wide range of applications, gas mixtures and pressures
- Solutions for extreme temperatures, and corrosive, toxic and/or flammable gases
- Full compliance with API 614/617
- Wide experience with various buffer gases

Dry gas seal

Did you know?

Dry gas seals – toxic gas mixtures Gasification vent gas blower, India

This compressor uses double dry-gas seals as the buffer to ensure that the mixture of air with traces of toxic hydrogen cyanide (HCN) stays within the system.

Inlet pressure	0.935 bar (a) (13.56 psia)
Outlet pressure	1.62 bar (a) (23.50 psia)
Flow	34 420 kg/ h (75 880 lbs/ h)
Inlet temperature	37 °C (99 °F)
Outlet temperature	102 °C (216 °F)
Power	750 kw (1 006 hp)

Carbon ring seals – lowest temperatures LNG facility, western Australia

This compressor at a LNG plant in western Australia has one of the lowest inlet temperatures of all our compressor references.

Inlet pressure	1.03 bar (a) (14.94 psia)
Outlet pressure	2.48 bar (a) (36 psia)
Flow	51 788 kg/ h (114 173 lbs/ h)
Inlet temperature	-160 °C (-256 °F)
Power	1 180 kW (1 582 hp)

BEARINGS: ENSURING ROTOR STABILITY AND RELIABILITY

Integral gearing delivers the optimal aerodynamics that give our compressors their highest possible efficiency. Perfectly matched bearings enhance this performance by providing best stability to high-speed rotors as well as main drive shaft. These bearings offer excellent anti-vibration and stability characteristics, while enabling easy inspection and maintenance.



Tilting pad axial bearing (combi bearing)



Tilting pad journal (lateral) bearing

Keeping everything spinning

The bull gear shaft, the main driver of the gearbox, is supported by multi-lobe sleeve bearings. One of these bearings is a combination of radial and thrust bearing with tapered land-thrust faces that allow rotation in either direction.

High-speed rotors are also supported by radial tilting pad bearings that are designed to compensate for their net thrust forces. These bearings reduce virtually all vibration and provide superior stability.

Oil supplied via nozzles (inside the bearings and close to the pads) ensures a consistent oil film as soon as rotation starts. This also minimizes oil use while keeping bearing pad temperatures low.

Lower-speed rotors often use sleeve bearings.

Meticulous engineering of all rotating parts, means friction, vibration and mechanical losses are kept to a minimum.

BEARINGS BENEFITS

- Specially engineered bearing designs for long life and exceptional reliability
- Eliminate virtually all vibrations and provide superior operating stability
- Thrust collars to reduce friction and minimize mechanical losses
- Horizontally split bearings allow easy inspection and maintenance
- Directed lubrication nozzles keep bearing pad temperatures low
- Bearings take into account oppositional forces created through compression and gearing



Did you know?

CO₂ compressor with specially designed bearings Urea fertilizer plant, Russia

This CO₂ compressor uses squeeze film damper bearings to compensate for cross-coupling between rotor vibration and gas flow.

Inlet pressure	Atmospheric
Outlet pressure	205 bar (a) (2 973 psia)
Flow	18 000 Nm ³ / h (10 594 scfm)
Inlet temperature	161 °C (322 °F)
Bearings	Horizontally split squeeze film high-dampening bearings; axial thrust bearings in higher stages

CO₂ compressor for Supercritical CO₂ Power Cycle Gas turbine driven compressor for sCO₂

This compressor provides high-pressure CO₂ to one of the firsts CO₂ Allam Cycle power generation plants for efficient power and minimal emissions.

Inlet pressure	25.3 bar (a) (367 psia)
Outlet pressure	90 bar (a) (1 305 psia)
Flow	334 300 kg/ h (737 000 lbs/h)
Inlet temperature	34 °C (93 °F)
Notable technology	Variable IGVs for potential turndown up to 35%; intercoolers to further reduce power consumption

BRIDGING TECHNOLOGIES: COMPANDER

The Compander merges the functions of a compressor and expander into one compact, efficient unit. It's an optimal solution for shipboard LNG liquefaction systems, for smaller onshore LNG plants, and for a host of petrochemical or chemical processes that require nitrogen or methane for cryogenic cooling.



Compander for chemicals process

A Belgian chemicals plant uses a Compander to reduce power requirements on one of its processes by nearly 36%.

Inlet pressure	0.974 bar (a) / 14.12 psia
Outlet pressure	8.7 bar (a) / 126.2 psia
Flow	148 000 m ³ /h (87 100 cfm)
Compressor power	12 682 kW / 17 000 hp
Expander recouped power	4 564 kW / 6 120 hp
Total power required	8 118 kW / 10 880 hp

Compander for on-board reliquefaction

Our Compander is used on many LNG tankers with reliquefaction, including Q-Flex and K-Line vessels.

Inlet pressure (N₂ compressor)	9.8 bar (a) / 142 psia
Outlet pressure (N₂ compressor)	39 bar (a) / 566 psia
Flow (N₂ compressor)	4 918 m ³ /h (2 895 cfm)
Inlet pressure (N₂ expander)	9.74 bar (a) / 141.2 psia
Outlet pressure (N₂ expander)	39 bar (a) / 565.5 psia
Flow (N₂ expander)	483 Nm ³ /h (284 scfm)

Greater efficiency with gas expansion

Utilizing the full energy recovery potential for combined compression and expansion processes, the Compander merges our long-standing expertise in integral gear compression technology and turboexpanders into one convenient and energy-saving solution.

It is a solution that meets key needs in many of today's industrial processes, where efficiency, smaller footprint and faster installation time are the name of the game.

Through its compact footprint – combining two machines (an integrally geared compressor and an expander) on a common base frame – the Compander is an ideal choice for offshore applications and LNG carriers as well as plants for small-scale air separation, acetic acid, N₂-based ssLNG and many other applications.

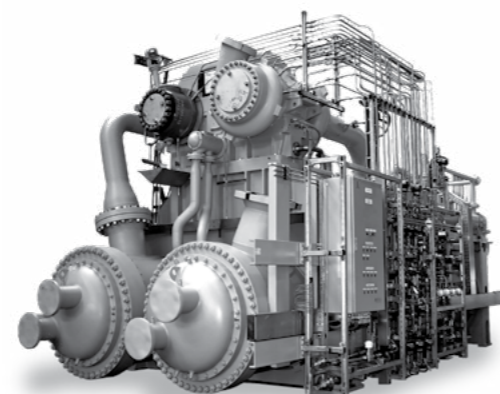

BUILDING BLOCKS OF CAPEX: STANDARDIZED COMPRESSORS

There are a number of reasons to opt for standardized solutions. They help reduce capital expenditures and operating costs, simplify maintenance and speed up delivery times. To help our customers benefit from these advantages, we offer several standardized skid / package compressor products, which still enable customized aerodynamics to process requirements.

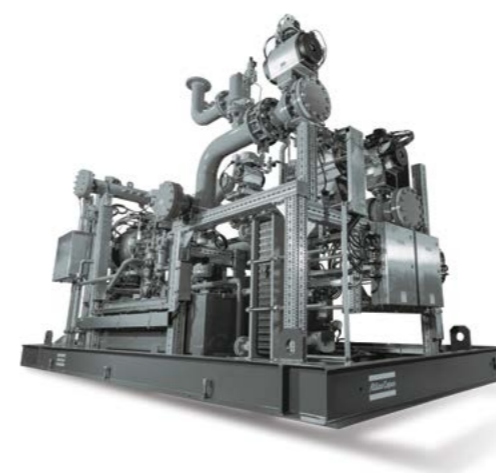

TurboBlock™ fuel gas booster

Our standardized TurboBlock™ compressor meets the power-generation industry's growing demand for fuel-boosting solutions. It features all the essential components of specialized compressors, including short lead times and longlasting reliability.

Inlet pressure	14 – 30 bar (a) (203–435 psia) (single stage) 8 – 22 bar (a) (116–319 psia) (multistage)
Outlet pressure	28 – 50 bar (a) (406 – 725 psia)
Outlet temperature	Up to 200° C (400 °F)
Flow	250 – 10 000 Nm ³ /h (150 – 282 500 scfm)
Power	745–5 220 kW (1 000–7 000 hp)

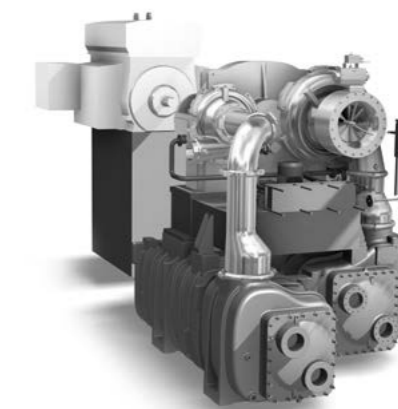

AeroBlock™ main air compressor

AeroBlock™ standardized main air compressors are ideal for air flow requirements of between 37,000 and 54,000 m³/hr. Manufactured in multiple cutting-edge facilities around the globe, the AeroBlock™ concept promotes faster turnaround time on orders.

Inlet pressure	0.795 – 1.05 bar (a) (11.5 – 15.2 psia)
Outlet pressure	6 – 13 bar (a) (87 – 189 psia)
Flow	37 000 – 54 000 Nm ³ /h (21 777– 31 783 scfm)
Inlet temperature	-29°C to 50 °C (-20°F to 122 °F)
Power	2 882 – 4 879 kW (3 865 – 6 543 hp)

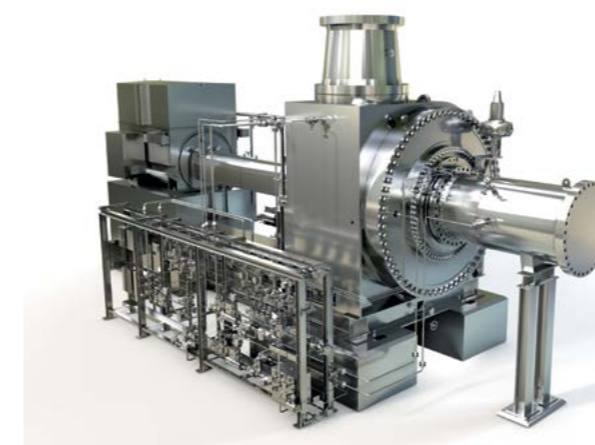

PolyBlock™ cycle gas compressor

Efficient, easy to maintain and with low operating costs, Polyblock™ cycle gas compressors are an optimal solution. The standardized model can be adjusted to meet your individual requirements and comes with our high-quality aftermarket service.

Inlet pressure	15 bar (a) (217.6 psia)
Outlet pressure	15.95 bar (a) (231 psia)
Flow	39 000 Nm ³ /h (22 955, acfm)
Inlet temperature	80 °C (176 °F)
Gas	Propylene Mix
Code	API 617 and API 614 (oil system), latest edition

OUR PRODUCTS FOR YOUR MARKET

Market / Application	Integrally-Geared Centrifugal Compressors		Non-Geared Centrifugal Compressors		Combined Service	Multi-Section Services	Companders
	Gas	Air / nitrogen	Gas	Air			
Oil and Gas (Midstream)							
FLNG	•	•				•	
FSRU	•						
Carrier LNG	•						•
Small-scale LNG	•	•				•	•
Large-scale LNG	•	•				•	
NGL Recovery / Gas Processing	•				•	•	
NGL Fractination / LPG	•					•	
Refineries	•	•			•	•	
Chemical / Petrochemical							
Olefins / Polyolefins	•	•	•			•	•
SynGas / Methanol / Hydrogen	•	•			•	•	
Specialty Chemicals / Aromatics	•	•	•		•	•	
Ammonia		•			•	•	
Chlorine	•	•					
Fertilizer							
Ammonia	•	•			•	•	
Urea	•	•			•	•	
Nitric Acid	•	•			•		•
Melamine	•	•					
Power Generation							
Fuel Gas Boosting	•						
Supercritical CO ₂	•	•			•	•	•
Industrial Gases							
Main Air Compressor (MAC)		•		•	•		
Booster Air Compressor (BAC)		•			•		
N ₂ Booster		•			•		
O ₂ Compressor	•						
CO ₂ Compressor	•						
Plant & Instrument Air	•	•					
HyCO	•					•	
Carbon Capture Storage	•	•					

ENGINEERING KNOWLEDGE AT YOUR SERVICE

At Atlas Copco Gas and Process, we know that building the very best compressors takes extensive expertise, state-of-the-art tools and dedicated engineers. Our commitment to excellence puts us in close contact with customers around the world, as we follow our compressors from initial design and testing through their long lifecycles.

COVERING THE ENTIRE COMPRESSOR PRODUCTION CYCLE

From milling, spinning and balancing to instrumentation and piping assembly, success in the turbomachinery business is built on exacting tolerances. We look to each and every detail with specific goals in mind: ensuring your efficiency and productivity over the long term.

Proven engineering expertise

Our engineering department sets standards in the areas of aerodynamics, rotor design, controlling technology, lubrication systems, pressure vessels and more.

Our specialists are backed by the latest software and design technology in aerodynamics, mechanics and package engineering.

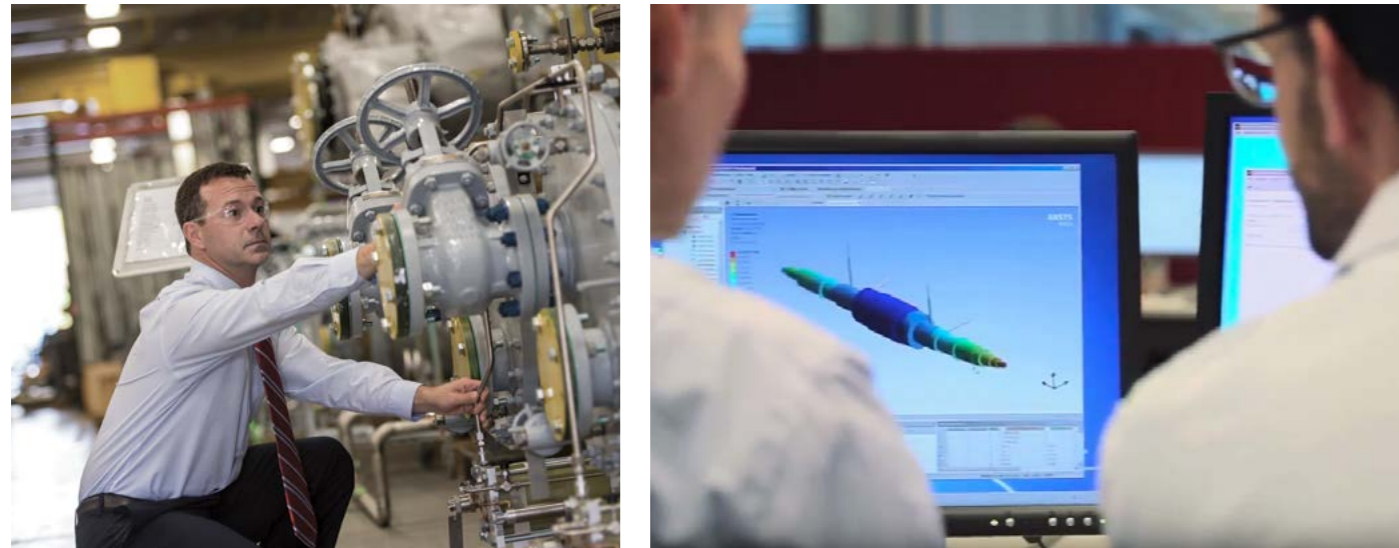

Aerodynamics

- OEM software
- Experimental measurements
- CFD analysis: ANSYS
- Gas programs: HYSYS, REFPROF, NIST, GPA, PR, SRK, FRG

Mechanics

- OEM software
- Rotor dynamics: SR3
- Rotor dynamics & bearings: Madyn
- Torsional analysis: DRESP
- FEA: ANSYS
- FVA workbench: RICOR, ST-Plus

Design

- 3D-CAD: Creo, MEDUSA / MPDS, Autodesk, Inventor, Solid Works
- 2D-CAD: MEDUSA
- Process design: HYSYS
- Component design: OEM software

Inside our production facilities

Long-term investments in machinery and infrastructure ensure we maintain the highest standards. This means we have the most up-to-date, cutting-edge production facilities to carry out our work. Working with the appropriate tools and processes, we use our extensive engineering expertise to create innovative, best-in-class products. And we will continue to invest in machinery and in the skills of our highly skilled employees.



High-speed rotor balancing machines



Impeller overspeed pit

In-house capabilities

Quality in every area of our production and maintenance is key to the way we work. This means that not only do we do the packaging locally, but we source peripheral components for best quality and delivery. In addition, we package all key components in-house, and this ensures premium quality as well as meaning we can maintain our delivery times. If you order from us, we enter into a long-term commitment to deliver the right service for you.

We rely on the best state-of-the-art production machinery for our components, which includes, milling, balancing and spinning equipment, for example. Moreover, we have a thoroughly modern production infrastructure that compares with anything across the globe, which provides the basis for fulfilling all your process needs. To back this up, we carry out constant product-performance reviews, and provide robust and strict quality assurances.



Inside the 5-axis machine: the milling process

FREQUENTLY ASKED QUESTIONS ?

Here are some of the most frequently asked questions we receive about turbomachinery, test and quality standards we comply with, as well as manufacturing process, packaging, testing facilities and aftermarket support. Feel free to reach out to us with specific queries.

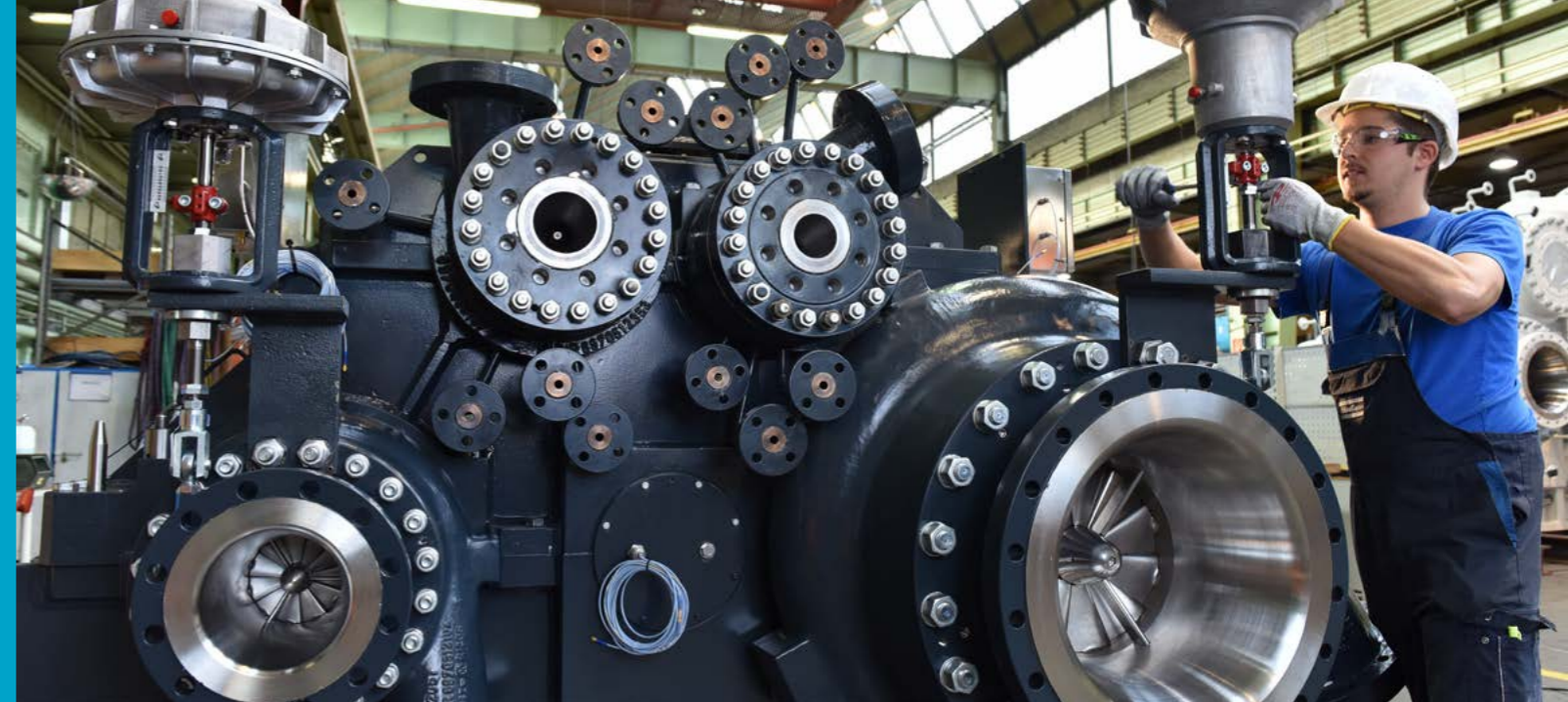

Q What pre-delivery testing is offered for centrifugal compressors?

As a standard quality assurance measure, all compressors are mechanically tested prior to shipment. We have the ability to simulate most operating conditions you might face, so your compressor is not only ready to perform from the start but to continue this over its long service life. A full range of performance testing is available upon request.

Our facilities have complete test beds and we can undertake all tests for full compliance with all major relevant standards, including DIN, ISO, VDI 2045, ASME, PTC 10 and API 617/672. We work closely with our customers in order to achieve our final goal: delivering the best product possible.



Q What international specifications and standards do your compressors meet?

We manufacture compressors to meet the rigorous standards set out by the American Petroleum Institute (API). This applies to gears, lube oil supply, rotor dynamic options and more.

Our compressors can meet API 617, Chapter 3 (gas) and API 672 (air) requirements, including oil systems that reflect API 614. We can also meet all major international, national, as well as manufacturer and end-user standards. This includes the ISO 11011 and ISO/TC 118/SC 1 standards, DIN, ASME Standard EA-4-2008, CENELEC and many others.

Ultimately, it's about making sure we provide the quality, efficiency, and sustainability you need to carry out your processes.

Q What aftermarket support do you provide?

Our global aftermarket services network consists of 7 service centers and 130+ sales engineers, protecting your machinery for a lifetime of sustainable productivity. The services range from on-site erection and commissioning to breakdown and repair.

Our expert engineers will be with you every step of the way to ensure that your plant and productivity remain functioning at the most optimal level. Our service plan, for example, comes with a fixed-rate maintenance program; preventative maintenance maximizes uptime,

helps avoid productivity downtime and provides proactive inspections; and when you need replacement parts, you will always receive genuine parts, backed up with our lifetime manufacturer guarantee.

Our production and testing are always carried out in-house by our expert personnel, which means that we guarantee the quality of every component at every stage. With our comprehensive aftermarket services, we provide you with tailor-made support to maintain your production as smoothly as possible.



Turbomachinery and test standards

- DIN
- VDI 2045
- ASME
- PTC 10
- API 617, Chapter 3 (gas)
- API 672 (air)
- API 614
- ISO 11011
- ISO / TC 118/SC 1
- EA-4-2008, CENELEC
- and many more

Our aftermarket services

- Genuine parts
- Breakdown & repair
- Preventive maintenance
- Service plan
- Redesign & upgrades
- All-brand services
- Advanced services

FREQUENTLY ASKED QUESTIONS ?

From building our products to precise specifications through packaging options and extensive testing, our aim is to ensure Atlas Copco Gas and Process compressors are ready for your process from day one. Feel free to reach out to us with specific queries.

Q What type of packaging options are available? Does Atlas Copco Gas and Process package according to API?

First, our growing number of standardized products are often delivered fully-packaged and ready for quick set-up. Our customized compressors are available in full-packaging, semi-packaging and free arrangement options. All but our very largest compressors can be built and transported in full or semi-packaging options.

Free arrangement enables our customers to take advantage of possibilities to locally source components – such as piping and cooling.

We are able to handle all relevant packaging to meet API and other major specifications. This can include highly specified packaging solutions. In-house manufacturing and packaging centers throughout the world in Germany, California, New York, China and India, as well as numerous service centers, keep packaging close to customers.

Q What quality compliance do you guarantee? What are your quality benchmarks?

Our focus on quality means that all of our equipment is designed and constructed for a minimum service life of 20 years and at least three years of uninterrupted operation.

Because we're active in numerous markets, we also adhere to a range of standards, including ISO, ASME, DIN, and CENELEC. This includes national and regional standards (such as those used in Australia, Russia and Japan), as well as the Marine Standard.



Finally, all our global facilities are subject to quality assurance programs certified to the ISO 9001 standard and registered by Lloyds Register Quality Assurance, Ltd. We are registered facilities for the following integrated management systems: ISO 14000 (environmental), ISO 9001 (quality), ISO 50001 (energy), and OHSAS 18001 / ISO 45001 (safety).

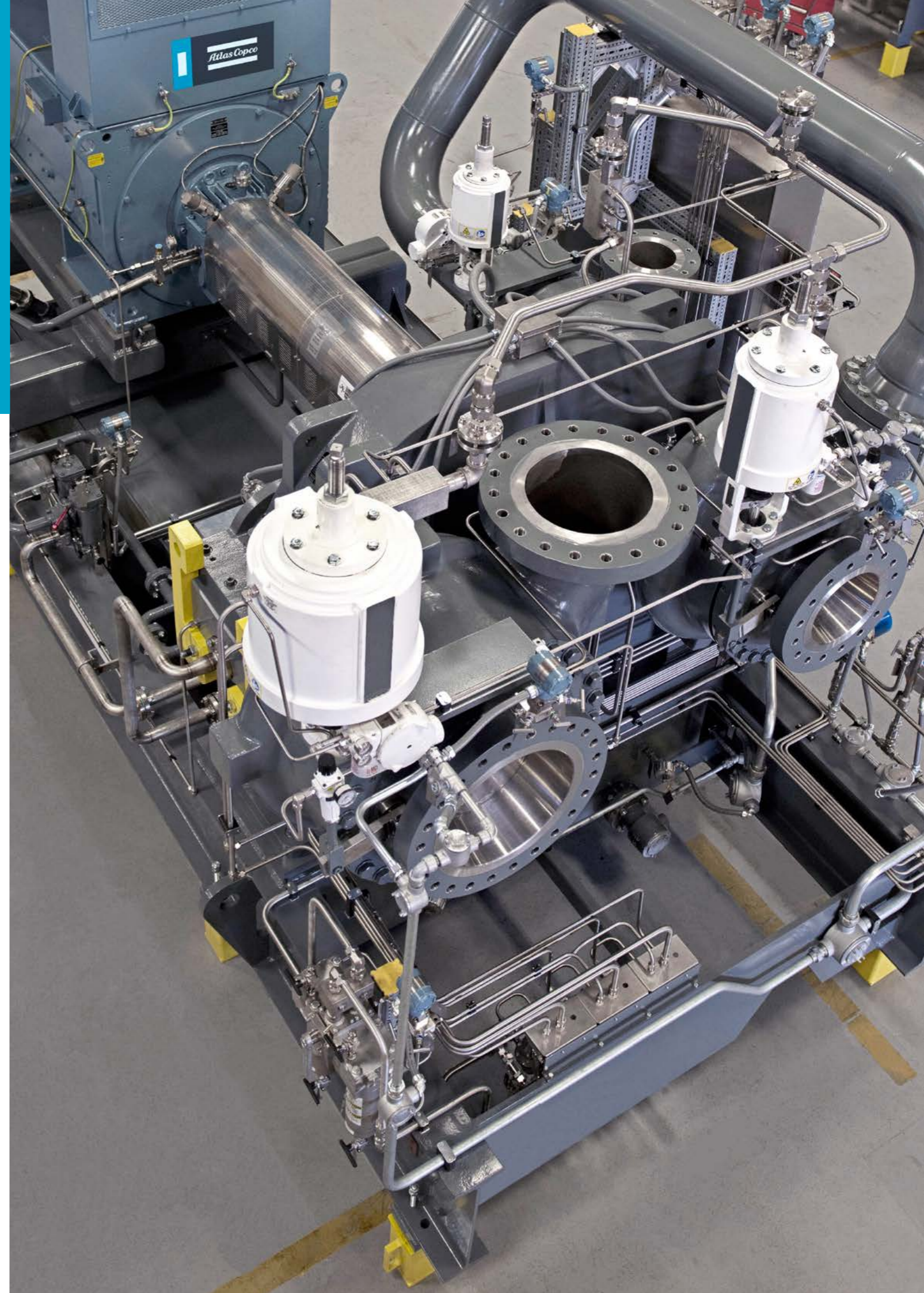

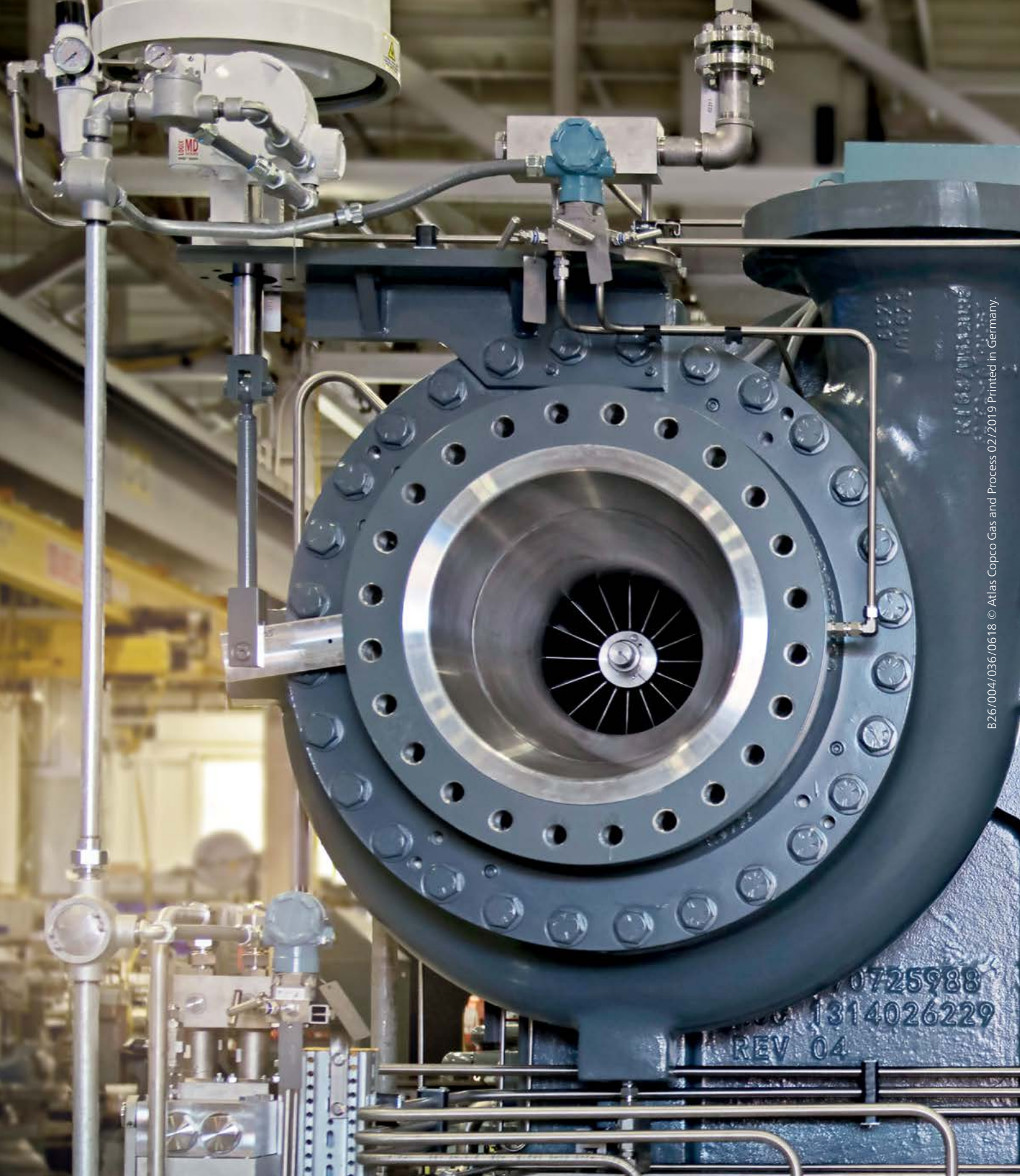

B26/004/036/0618 © Atlas Copco Gas and Process 02/2019 Printed in Germany.

0725988
1314026229
REV 04



Atlas Copco Gas and Process
Schlehenweg 15, 50999 Cologne, Germany
Phone: +49 2236 96 50 0
www.atlascopco-gap.com

